

MARCH 1968

TAPE

RECORDING MAGAZINE

2¹/₂

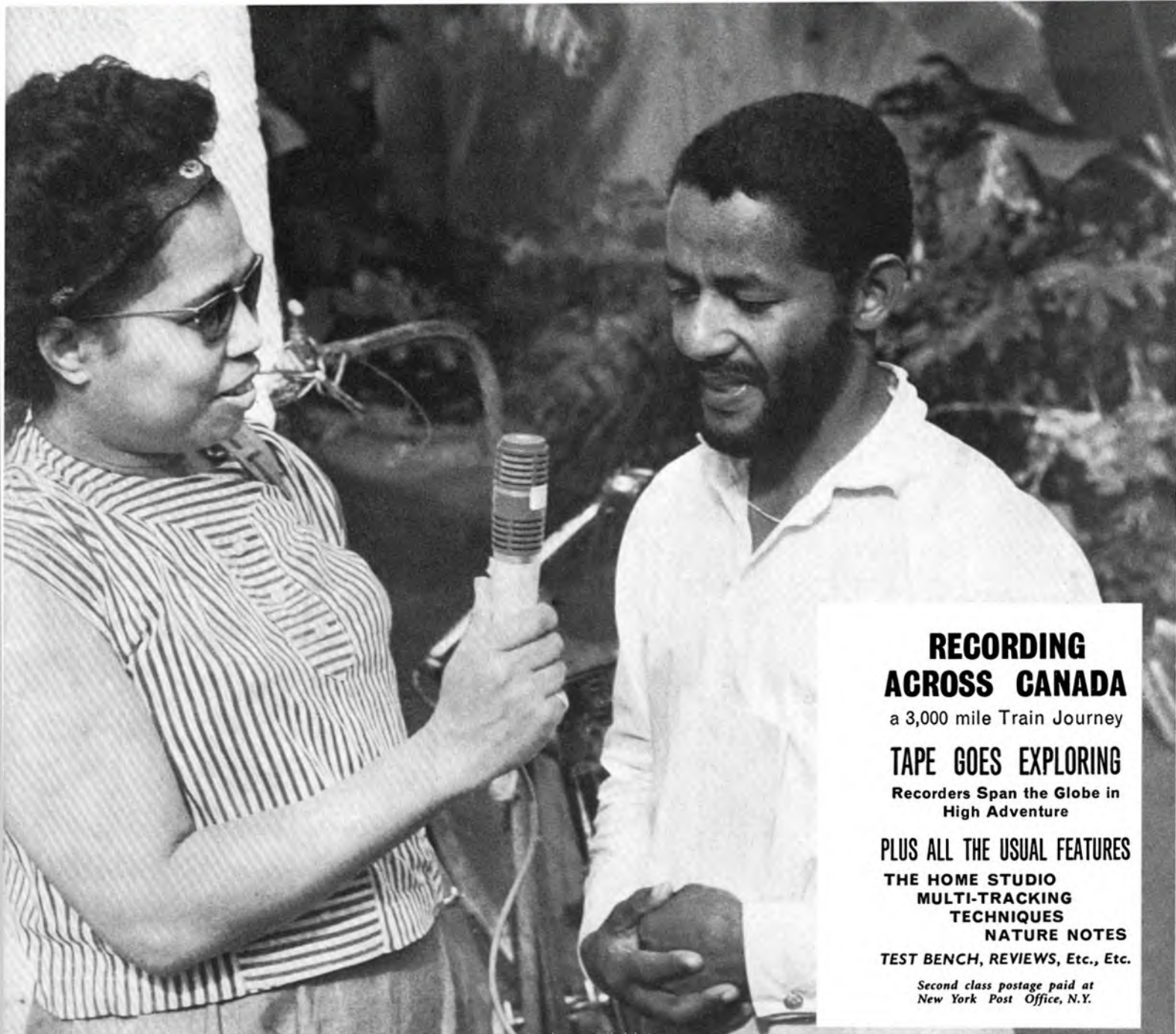

RECORDING ACROSS CANADA

a 3,000 mile Train Journey

TAPE GOES EXPLORING

Recorders Span the Globe in
High Adventure

PLUS ALL THE USUAL FEATURES

**THE HOME STUDIO
MULTI-TRACKING
TECHNIQUES**

NATURE NOTES

TEST BENCH, REVIEWS, Etc., Etc.

*Second class postage paid at
New York Post Office, N.Y.*

Slow
slow
quiet
quiet
slow

Quite.
'Scotch' Low-Noise 'Dynarange' tapes reduce background noise.
They also increase your dynamic range.
And improve your frequency response.
So you can reduce recording speeds if you want.
In fact you can *halve* them. Without losing quality.
So you save money, even though you pay a bit more.
Or you can exploit that increased dynamic range and improved frequency response.
And make the best recordings you've ever heard in your life.



202 STANDARD PLAY
sizes: 5", 5½" and 7"
203 LONG PLAY
sizes: 5", 5½", 7" and 8½"

For Price List of the full 'Scotch' range with technical details, write to: G. C. Wride, Magnetic Products Division, 3M Company, 3M House, Wigmore Street, P.O. Box 1.E.T., London, W.1.

Scotch  3M  DYNARANGE

3M. 'Scotch' and 'Dynarange' are trademarks of Minnesota Mining and Manufacturing Company

We'd like you to hear our latest number

It's the TK145 de luxe. And it's quite a tape recorder

Grundig have built quality into every inch of this four-track machine. Recording level adjustment is fully automatic, by means of the unique Grundig 'Magic Ear'. This ingenious device acts with split-second precision, and retains natural loudness variations *without distortion*. And when you want it, manual operation is yours at the click of a switch!

The TK145 de luxe has a frequency response of up to 12,500 Hz, Wow and flutter below $\pm 0.2\%$, and a signal to noise ratio of 48 dB. Result? Clean, crisp, *life-size* reproduction.

What's more, you can make synchronised recordings by using the Monitoring Amplifier MA2, and the Earphones type SE3, both available as extras.

There are connecting sockets for recording/playback, monitor headphones and switchable extension loudspeaker. There's even a press-button reset for the position indicator! And—to guarantee cool operation over long periods of playing and recording, the TK145 de luxe has the exclusive Grundig single-unit combination of motor and mains transformer.

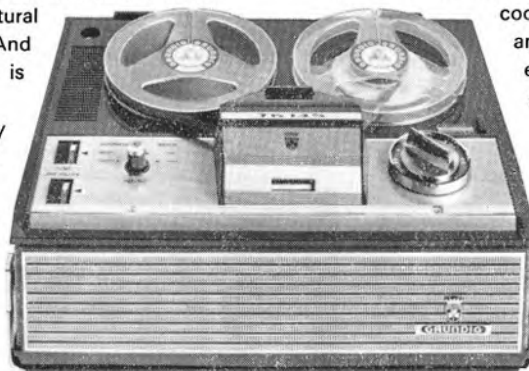

The uncrushable steel chassis is elegant in teak finish, with Silver G-line grille. The TK145 de luxe comes with 1,200 ft. of tape and a high-quality dynamic microphone... all that for just 46 gns! Like to hear more? Then send off the coupon *today* for full details of all ten Grundig 2 and 4 track tape recorders ranging in price from under 33 gns. to 147 gns.

To: Grundig (G.B.) Ltd., Dept. TM5, London, S.E.26.

Please send me 'The Sound of Grundig' all-colour
tape-recorder leaflet radio leaflet audio unit
and stereogram leaflet *Tick which you require.*

NAME _____

ADDRESS _____

TM5

GRUNDIG

Tandberg

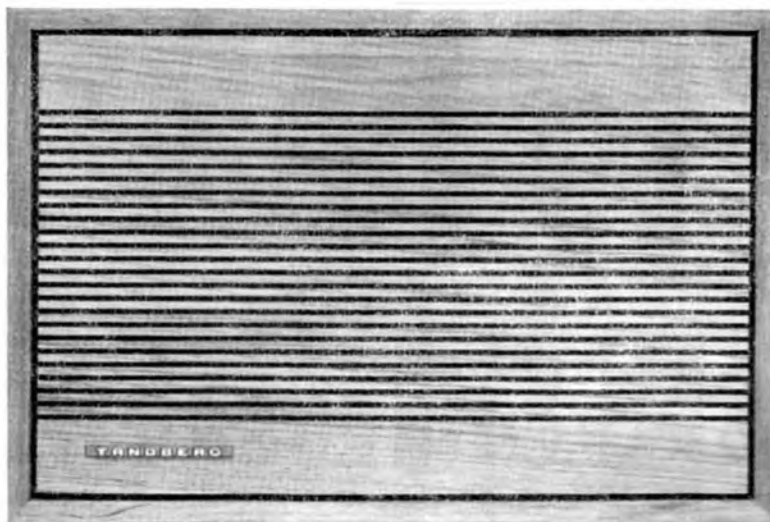

the unspoken Loudspeaker

It's sad to think that the first product Tandberg ever made, the Tandberg loudspeaker, has fallen from the Hi-Fi public's eye.

But we take the entire blame. You see, we've devoted so much time in giving you a world beating range of radios, of tape recorders, that we've neglected to keep you abreast of developments on our original product.

For full details, please contact:

Dept. TRM 19
Elstone Electronics Ltd.,
Hereford House,
Vicar Lane, Leeds, 2.

	Hi-Fi System 10	Hi-Fi System 11	Hi-Fi System 12	Hi-Fi System 7	Hi-Fi System 13	Hi-Fi System 14
	Woofers 6½" Tweeter 2"	Woofers 6½" Tweeter 2"	Woofers 6½" Tweeter 2"	Woofers 10" x 6" Tweeter 2"	Woofers 10" x 6" Tweeter 2"	Woofers 10" Tweeters 2 x 2½"
Internal volume	6,5 litres	6,5 litres	12,5 litres	25 litres	25 litres	50 Litres
Impedance (at 400 c/s)	4 ohms	4 ohms	4 ohms	3,2 ohms	3,2 ohms	4 ohms
Max. continuous input	8 W	8 W	8 W	8 W	8 W	15 W
Frequency response	60-16000 c/s	60-16000 c/s	50-16000 c/s	60-16000 c/s	60-16000 c/s	45-16000 c/s
Dimensions	L: 7½" B: 9½" H: 9½"	L: 12½" B: 6" H: 8½"	L: 17½" B: 7½" H: 8¾"	L: 20½" B: 10" H: 10½"	L: 25½" B: 9½" H: 8½"	L: 27½" B: 11" H: 13½"
Price	£14-0-0	£14-0-0	£15-10-0	£23-0-0	£23-0-0	£31-0-0

move up to **Tandberg**

See and Hear a full demonstration of Tandberg Loudspeakers at

BARNSELY

Geoffrey Barnard, 3 Pitts Street.

BIRMINGHAM

Ken Whittle, 788 Stratford Road, Sparkhill.

The Photo Centre, Erdington. Gratispool, 10 & 12, Martineau Way.

BISHOP AUCKLAND

McKenna & Brown, Newgate Street.

BLACKPOOL

The Tape Recorder Centre, 266 Waterloo Road.

BRADFORD

Vallance & Davison Ltd., Arndale House, Market Street.

BRIGHTON

Lanes Radio Ltd., 11 Gardner Street.

BRISTOL

Audio-Bristol, Park Street Avenue. Sound Selections Ltd., 363 Gloucester Road.

BROMLEY

Sound Systems, 218 High Street.

CARDIFF

J. Gough & Co. Ltd., 148-154 North Road.

CARMARTHEN

Mayfair Photographic Ltd., 7 John Street.

CHESTERFIELD

Roy Smith Ltd., Cavendish Street.

COVENTRY

R.E.S. (Coventry) Ltd., 13 City Arcade.

CREWE

Charlesworths of Crewe Ltd., 28 High Town.

DARLINGTON

McKenna & Brown, 11 Bondgate.

DERBY

Victor Buckland Ltd., 27-39 London Road.

DONCASTER

Fields Radio, 52 Hallgate.

EDINBURGH

Hi-Fi Corner, 1 Haddington Place.

GLASGOW

G. H. Steel & Co. Ltd., 141 St. George's Road.

GRIMSBY

G. F. Manders, 2-4 Edward Street.

HADLEIGH

Croisette Radio, 212 London Road.

HARROGATE

Hulse Camera Shop, 2 Cambridge Street.

HULL

A. Brown & Son Ltd., 26 George Street.

LEEDS

R. Barker & Co. Ltd., 91 The Headrow.

John Peters Ltd., Commercial Street.

LEICESTER

Hi-Fi Stereo Ltd., Forrester's Buildings, St. Nicholas Street.

LONDON

Francis of Streatham, 169 High Road, S.W.16.

Nusound, High Street, Lewisham, S.E.13.

Davis & Kays (Photographic) Ltd., 115 Kingsway, W.C.1.

Largs of Holborn, 76 High Holborn, W.C.1.

MANCHESTER

Rare Records, 36 John Dalton Street.

Godley, Spears Ltd., 2 Shuedhill.

MIDDLESBROUGH

McKenna & Brown, 122 Linthorpe Road.

NEWCASTLE

J. G. Windows Ltd., 17 Central Arcade.

NORTHAMPTON

A. R. Hawkins Ltd., 2 The Parade.

NORWICH

Telefusion Ltd., 43-45 West End Street.

NOTTINGHAM

Peter Anson Electronics Ltd., 165 Arkwright Street.

PLYMOUTH

Tom Molland Ltd., 102 Cornwall Street.

REDCAR

McKenna & Brown, High Street.

ROMFORD

Le Connoisseur Sound & Electrical, 160 Heath Park Road.

RICHMOND

F. Cave Ltd., 27 High Street.

SHEFFIELD

Philip Cann Ltd., 4 Chapel Walk, Fargate.

R.S.C. (Manchester) Ltd., Exchange Street.

Sheffield Photo Co. Ltd., Norfolk Row, Fargate.

SLEAFORD

James Hughes Ltd., 10 Westgate.

SALISBURY

J. F. Sutton, 15-18 Queen's Street.

SOUTHAMPTON

University Audio, 12 Bargate Street.

TEDDINGTON

Daytronics Ltd., 119a High Street.

WIGAN

H. Plumb & Sons, 1a Diconson Street.

WOLVERHAMPTON

M. R. Warner & Son Ltd., 26 Chapel Ash.

WILMSLOW

The Transistor Centre, Harrison's Buildings, Green Lane.

YORK

J. Saville & Sons Ltd., 7 Goodramgate.

sounds great —'68

INTERNATIONAL AUDIO FESTIVAL & FAIR

Thursday April 18th to Sunday April 21st 11 a.m.—9 p.m.

On show the finest of the world's sound reproduction equipment.

Hear continuous demonstrations of the newest equipment to keep you abreast of all that is latest and best in Pick-ups, Amplifiers, Speakers, Microphones, Stylies, Turntables, Tapes, Tape Recorders . . . plus a huge variety of accessories.

**NOT ONLY SUPERIOR SOUND
BUT SUPERIOR MANUFACTURE**

HOTEL RUSSELL,
Russell Square, London, W.C.1.

ASK FOR COMPLIMENTARY TICKETS
at your nearest AUDIO, RECORD, RADIO or
MUSIC Shop, or send stamped addressed envelope to:

AUDIO HOUSE, 42 Manchester Street, London, W.1.

No Gimmicks

Tandberg Series 6x. Just outstanding quality, performance and reliability.

Tandberg just don't go in for gimmicks. No superfluous knobs and levers, no flashy strips of plastic, no buttons begging to be broken.

The interior circuitry is more likely to bring a glow to an engineer's eyes. And why not. The Tandberg 6X combines outstanding performance in an incredibly compact case (total weight 23 lbs.).

* Incredible signal-to-noise and frequency response at all speeds.

* Multiplex filters (for stereo radio recording).

* Centre channel amplifier for simultaneous play-back of two tracks.

* Fully transistorised oscillator circuit.

* Cathode follower outputs.

* On and off the tape monitoring.

* Sound-on-sound facilities.

* 2-4 track, 3 speed. 118 Gns.

All Tandberg prices will be maintained whilst current stocks last

For full details on the Tandberg 6x please contact.

Dept. TRM 17

Elstone Electronics Limited, Hereford House, Leeds, 2.

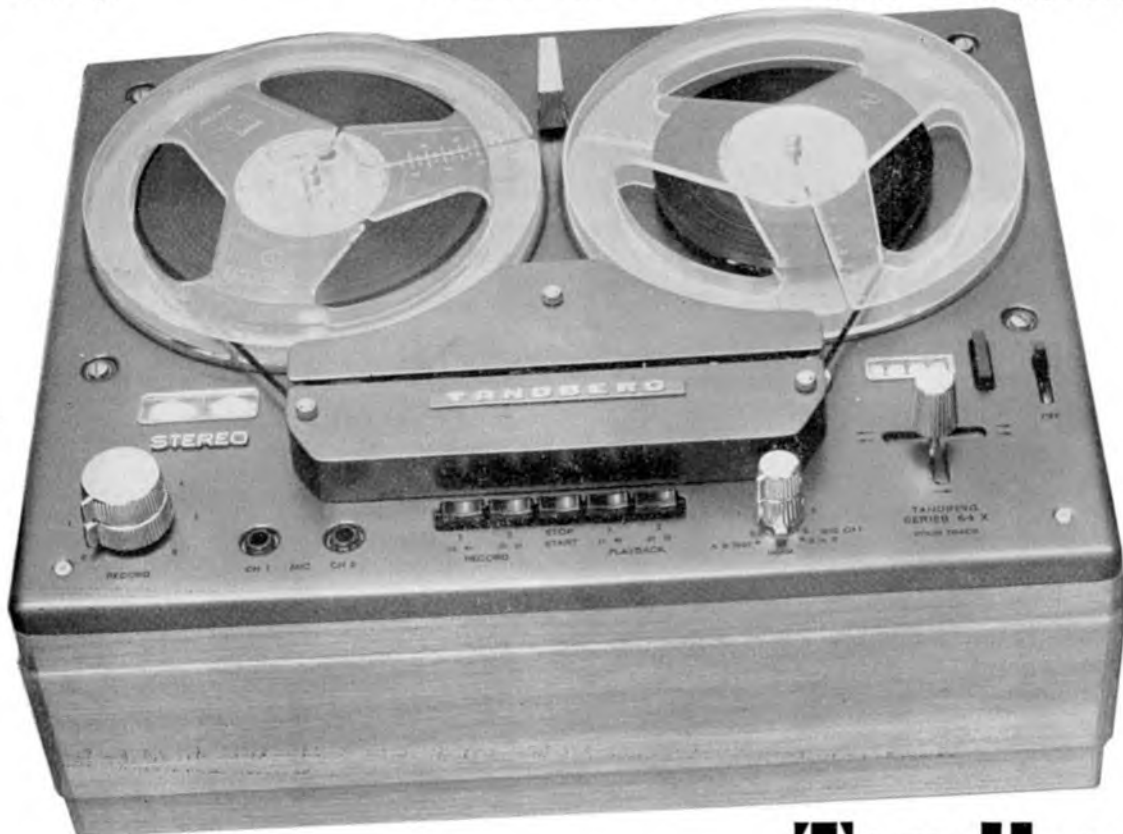

move up to **Tandberg**

IMMEDIATE DELIVERY!

K. J. ENTERPRISES

EVERYTHING AUDIO!

BRITAIN'S PREMIER MAIL-ORDER RECORDING TAPE SPECIALISTS

IMMEDIATE 24 HOUR SERVICE ON ADVERTISED LINES

FULL CASH REFUND GUARANTEED

SEND TODAY AND SAVE!

BRANDED TAPES

20% OFF

**BASF—EMI—GRUNDIG—PHILIPS
SCOTCH—AGFA—KODAK**

STANDARD PLAY	LIST PRICE	OUR PRICE
5" 600'	21/-	16/10
5½" 900' } Except	28/-	22/6
7" 1,200' } Agfa	35/-	28/-

LONG PLAY	LIST PRICE	OUR PRICE
3" 210' (Not Scotch or Kodak)	9/-	7/3
3" 300' (Scotch only)	9/6	7/6
3½" 300' (Kodak only)	12/-	9/6
4" 450' (Except Kodak)	14/6	11/8
4½" 600' (BASF, Agfa only)	21/-	16/10
*5" 900'	28/-	22/6
*5½" 1,200'	35/-	28/-
*7" 1,800'	50/-	35/-
8½" 2,400' (BASF, Scotch only)	72/6	58/-
10" 3,280' (Agfa only)	85/-	68/-
10" 3,600' (BASF only)	95/-	76/-
10½" 4,200' (Agfa, BASF only)	112/-	90/-

SCOTCH DYNARANGE (L/P)	LIST PRICE	OUR PRICE
5" 900'	32/3	25/10
5½" 1,200'	40/6	32/6
7" 1,800'	57/6	46/-
8½" 2,400'	83/6	66/10

COMPACT CASSETTES	LIST PRICE	OUR PRICE
C.60	17/6	14/-
C.90	25/-	20/-
C.120	33/6	27/-

Grundig Tape available only where marked with asterisk. Postage and Packing 2/-. ORDERS OVER £3 POST FREE

FERROGRAPH TAPE—20% OFF!

Brand New. Fully guaranteed and in normal manufacturer's pack.	LIST PRICE	ONE	THREE	SIX
BN7 1,200' on 7" reel (Dynarange)	50/-	40/-	117/6	230/-
BN8 1,800' on 8½" reel (Dynarange)	71/-	57/-	168/-	330/-
BL7 1,800' on 7" reel (Dynarange)	70/-	56/-	165/-	324/-
BL8 2,400' on 8½" reel (Dynarange)	90/-	72/-	213/-	420/-

Post and Packing 2/-. ORDERS OVER £3 POST FREE.

ILFORD TAPE NEAR HALF PRICE

A BULK PURCHASE OF PREMIUM GRADE, TOP QUALITY, POLYESTER MAGNETIC TAPE FROM ONE OF THE WORLD'S FOREMOST EXPERTS IN FILM COATING TECHNOLOGY, WITH FULL LEADER, STOP FOIL, POLYTHENE WRAPPING, AND IN ORIGINAL MANUFACTURER'S BOXES. AVAILABLE IN LONG-PLAY BASE ONLY AT THESE BARGAIN PRICES.

	One	Three	Six
900' on 5" reel	List Price 28/-	16/6	48/-
1800' on 7" reel	List Price 50/-	32/6	95/-

Please add 2/- P. & P. ORDERS OVER £3 POST FREE

SENSATIONAL NEW HALF-PRICE OFFER!

A bulk purchase of top quality Recording Tape manufactured by one of the country's leading makers. A polyester based tape with superlife black coating. Polythene wrapped boxed and fully guaranteed. Available while stocks last in one size only.

1800' on 7" reel Long Play	Normal Value	ONE	THREE	SIX
	50/-	26/-	72/-	150/-

Postage and Packing 2/-. ORDERS OVER £3 POST FREE

AMPEX TAPE 25% OFF

BRAND NEW, FULLY GUARANTEED & IN NORMAL MANUFACTURER'S PACK '500' SERIES AUDIO TAPE (MYLAR BASE)

TYPE	DESCRIPTION	LIST PRICE	ONE	THREE	SIX
541-9	900' L/P 5" reel	28/-	21/-	61/6	120/-
541-12	1,150' L/P 5½" reel	35/-	28/-	82/6	162/-
541-18	1,800' L/P 7" reel	50/-	32/6	96/-	189/-
551-12	1,200' D/P 5" reel	42/-	35/-	103/6	204/-
551-16	1,650' D/P 5½" reel	56/-	45/-	133/6	264/-
551-24	2,400' D/P 7" reel	72/6	55/-	163/6	324/-

'600' SERIES PROFESSIONAL AUDIO TAPE (MYLAR BASE)

	DESCRIPTION	LIST PRICE	ONE	THREE	SIX
641-9	900' L/P 5" reel	30/6	23/-	66/6	127/6
641-18	1,800' L/P 7" reel	52/6	39/6	116/-	226/-
651-12	1,200' D/P 5" reel	46/-	34/6	101/-	197/-
651-24	2,400' D/P 7" reel	80/-	60/-	177/-	348/-

Post & Packing 2/-. Orders over £3 Post Free

N.B.—OTHER TYPES & SIZES AVAILABLE INCLUDING THE INEXPENSIVE "WHITE BOX" SERIES

SPECIAL OFFER COMPACT CASSETTES

"MC 60"



Compact Cassettes with 60 mins. playing time. Brand new and packed in normal plastic library box—available at this exceptional price.

NORMALLY 17/6 OUR PRICE 13/-

Standard pattern to fit Philips, Stella, Elizabethan, Dansette, Sanyo, etc.

3 for 38/3 6 for 75/- 12 for 144/-

Post & Packing 2/-

Orders over £3 Post Free

BASF TAPE—30% Reduction

A SPECIAL OFFER OF THIS FAMOUS PREMIUM GRADE TAPE Brand new, boxed, with full leader, stop foil and polythene sealed. Multiples of three 4" size can be supplied in the BASF 3 compartment plastic library cassettes at no extra cost.

Type	Description	List Price	One	Three	Six
LGS 26	600' D/P 4" reel	25/-	17/-	49/-	93/-
LGS 26	1200' D/P 5" reel	42/-	29/6	86/-	166/-
LGS 26	1800' D/P 5½" reel	55/-	38/6	112/6	219/-
LGS 26	2400' D/P 7" reel	77/6	49/6	145/6	285/-

Post and Packing 2/-. ORDERS OVER £3 POST FREE.

TRIPLE PLAY TAPE—40% OFF!

A large purchase from TWO world renowned manufacturers enables us to make this unique half-price offer. Brand new, fully guaranteed, premium grade Polyester Base Tape with FULL LEADER and stop foil. In original maker's boxes and polythene wrapped at these EXCEPTIONALLY LOW PRICES.

	List Price	One	Three	Six
450' on 3" reel Gevasonor	22/-	14/-	40/6	78/-
600' on 3" reel Gevasonor	27/6	17/6	51/-	99/-
900' on 4" reel Gevasonor	39/-	24/6	72/-	140/-
2400' on 5½" reel Zonal	90/-	55/6	165/-	324/-

Post and Packing 2/-, ORDERS OVER £3 POST FREE.

20% off all Grundig and Philips equipment.

SEND FOR LISTS OF OTHER TAPE AND HI-FI BARGAINS

K. J. ENTERPRISES, (Dept. T), 17 THE BRIDGE, WEALDSTONE, MIDDLESEX (OPPOSITE HARROW & WEALDSTONE STATION) 01-427 0395 (CLOSED P.M. SAT.) REFUND GUARANTEE

FREE

Our New Illustrated catalogue sent entirely free on request. Britain's most specialized comprehensive range of recording tape and accessories. 20,000 reels always in stock with reductions ranging up to 50%.

We planned a

SALE!

And, in fact, Budget or no Budget, we're having one. But stocks are moving so fast that we can't give you all the information on available bargains which we'd like. What we can do is to invite you to either of our two showrooms (come soon and come early) and tell you that if you're looking for BARGAINS, by golly you'll find 'em. We have a vast range of top quality hi-fi and tape equipment—only two or three items left of some—which simply must be cleared at "squeeze" prices. Everything on interest free terms, of course. Or if you're paying cash we could be persuaded to offer something really special by way of discount. Try us and see. We can promise real opportunities for callers.

● TERRIFIC STOCKS! ●

at
**PRE-DEVALUATION AND
 PRE-BUDGET PRICES**
 while stocks last
... but hurry!

☆ Akai ☆ Sony ☆
 ☆ Sanyo ☆ Sansui
 ☆ B&O ☆ Dual ☆ Philips



You will always find a friendly welcome at our new enlarged showrooms at 146, Charing Cross Road, just opposite the Astoria Cinema. Overseas visitors will find our Personal Export Service really helpful. Equipment can be despatched immediately free of UK Purchase Tax. Careful, experienced packing, fast service and prompt delivery arranged anywhere in the world.

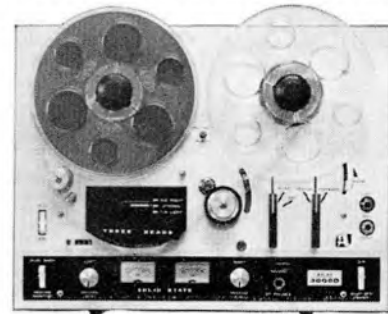
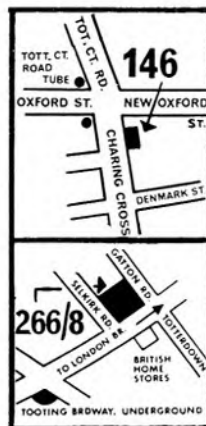

We have ample stocks of the sensational new **AKAI 3000D Stereo Tape Deck**. Superbly engineered, four tracks, two speeds. High quality, three-head system incorporates all-silicon transistor amplifier. **81 gns. cash, or on interest-free terms, £21.6.0 deposit and 12 monthly payments of £5.6.3.**

Save 27 gns. on the fabulous **AKAI M8**. List 135 gns., **R.E.W.'s price only 108 gns.** Four speeds, four tracks, frequency response 30-25,000 c/s at 7½ ips. **Or on interest-free terms, £28.7.0 deposit and 12 monthly payments of £7.1.9.**

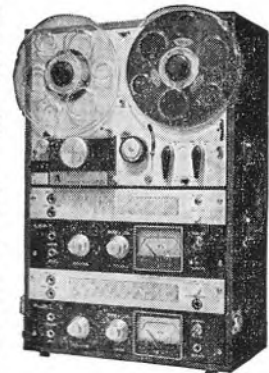

Save 20 gns. on the **TELEFUNKEN 204E STEREO**. List 106 gns. **R.E.W.'s price only 86 gns.** Four track recording/playback, frequency response 40-18,000 c/s at 7½ ips. 6W channel output. **Or on interest-free terms, £22.12.0 deposit and 12 monthly payments of £5.12.10.**

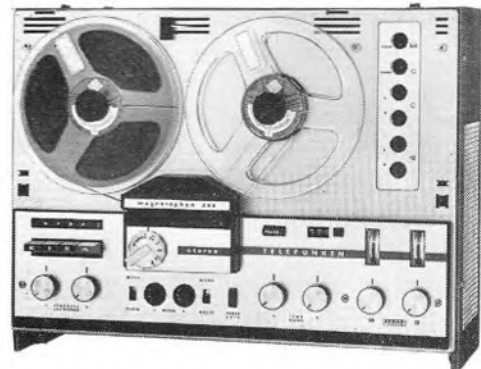

Gt. Britain's Largest Hi-Fi and Tape Recorder Dealers!



R·E·W (EARLSFIELD) LTD ★ LEADERS IN MAIL ORDER HI-FI ★

● **HEADQUARTER SHOWROOMS AND MAIL ORDER:** DEPT. TRM. 266-8 UPPER TOOTING ROAD, LONDON, S.W.17. Tel.: 01-672 8267 or BAL 9175
 ● **WEST END SHOWROOMS:** 146 CHARING CROSS ROAD, LONDON, W.1. Tel: 01-836 3365 (opposite Astoria Cinema)

B-M-B

acos

See your dealer about this service FOR THE TAPE RECORDER ENTHUSIAST - A NEW PRODUCT RANGE



Microphones from 24s. each

Aerosol tape head cleaner 7s. 6d.

Tape spools—5 inch 1s. 9d. each,
5 $\frac{3}{4}$ inch 2s. each, 7 inch 2s. 6d. each.

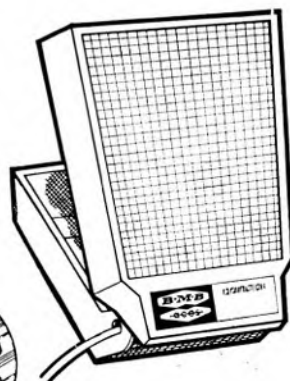
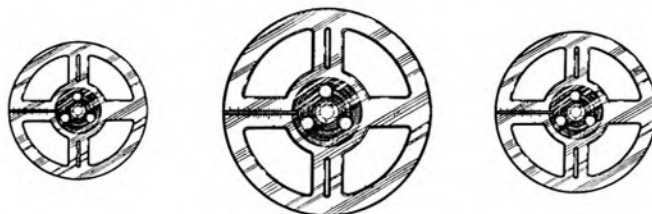

B.M.B. (SALES) LTD., CRAWLEY, SUSSEX.
Telephone: CRAWLEY 28765. One of the B.M.B. Group of Companies.

THE AKAI CENTRE

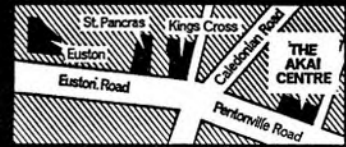

SPECIAL AKAI OFFERS! BRAND NEW, LATEST MODELS AT SPECIALLY REDUCED PRICES!



Complete with full maker's guarantee. Limited number only—hurry while still available.

AKAI 1710. The latest version of this wonderful 4-track stereo model. List 79 gns.

OUR PRICE
69 gns



AKAI M8. Finest 4-track stereo recorder. List 125 gns.

OUR PRICE
109 gns.

FULL RANGE ON DISPLAY

Every model in the **AKAI** range is in stock for immediate demonstration and comparison together with every other make of tape recorder available today.

EXPERT ADVICE - EXPERT SERVICE

Ray Churchouse and his staff are all 100% **AKAI** enthusiasts and are able to give you expert advice and technical assistance based upon years of selling not only **AKAI** but every other make and type of Tape Recorder.

EASY TO GET TO

THE AKAI CENTRE is situated only 100 yards from easy-to-get-to Kings Cross and St. Pancras main line stations (see map above).



REMEMBER—IF IT'S **AKAI** YOU ARE INTERESTED IN THEN **THE AKAI CENTRE IS THE PLACE TO VISIT.**

THE AKAI CENTRE, 242/4, PENTONVILLE ROAD, LONDON, N.1. Telephone TERminus 8200
Open Monday to Saturday 9 a.m. to 6 p.m. (Half day Thursday)

HEATHKIT

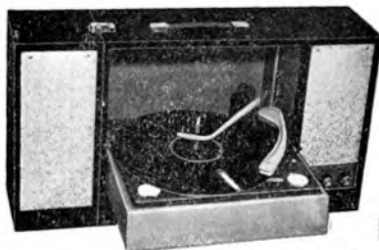

Transistor Portable Stereo Record Player

SRP-1

TOTAL PRICE
Kit £27 15 0

- Automatic Playing of 16, 33, 45 and 78 rpm records
- All transistor circuitry ensures cool instant operation
- Dual sapphire stylus for LP's and 78's
- Plays mono as well as stereo records
- Compact, with easy to carry handle for suitcase portability
- Detachable speaker enclosure for best stereo separation
- Two 8 in. by 5 in. speakers
- Operates on 220-250V ac supply.

So Easy to Build — So Easy to Use!

MANY OTHER HI-FI MODELS IN RANGE



New! Transistor Stereo Amplifier Kit TSA-12 from £30.10.0 less cabinet



Transistor AM/FM Stereo Tuner Kit AFM-2 £32.7.0 incl. P.T.

Deferred Terms available in U.K. on £10 Mail Order prices quoted. Retail prices slightly higher.

present their NEW! STEREO TAPE RECORDER

STR-1 only £45-18-0 kit £59 15s. Assembled

FOR THIS SPECIFICATION

- $\frac{1}{2}$ track stereo or mono record and playback at $7\frac{1}{2}$, $3\frac{1}{2}$ and $1\frac{1}{2}$ ips
- Sound-on-sound and sound-with-sound capabilities
- Stereo record, stereo playback, mono record and playback on either channel
- 18 transistor circuit for cool, instant and dependable operation
- Moving coil record level indicator
- Digital counter with thumb-wheel zero reset
- Stereo microphone and auxiliary inputs and controls, speaker headphone and external amplifier outputs . . . front panel mounted for easy access
- Push-button controls for operational modes
- Built-in stereo power amplifier giving 4 watts rms per channel
- Two high efficiency 8 in. by 5 in. speakers
- Operates on 230V ac supply.



So Easy to build . . . Simple step-by-step instructions and large pictorial diagrams guide you all the way. Maximum portability — Versatile Recording Facilities—Transistor circuitry offers cool reliability.

See Britain's Finest Range of Electronic Kits in the latest FREE Catalogue

To **DAYSTROM LTD.**, Gloucester. Tel.: 20217 tick **FREE BRITISH HEATHKIT CATALOGUE**

Please send Free Heathkit Catalogue to my Friend

Full details of Model(s).....

Name

Name

Address

Address

Address

(Block capitals please)..... T.I

..... T.I



Box clever!

GET MASTERTAPE
IN THE TERRIFIC
NEW TAPE BOOKS



The modern way to buy your recording tape. New Mastertape Tape Books are both practical and attractive—a one piece tape book in unbreakable black plastic with gold lettering and colour coded for standard, long, double and triple play covering the popular sizes of 5", 5 $\frac{3}{4}$ " and 7". Standardise your personal tape library with Mastertape Tape Books—fine packs for a fine recording tape. Available now at your usual tape stockist.





mastertape

IN THE TERRIFIC NEW TAPE BOOKS

Manufactured in England by
Mastertape (Magnetic) Limited. Colnbrook, Slough, Bucks.

Microphones

for every purpose

	<p>The DP4</p> <p>Designed for general use —P.A., tape recording etc.</p>
	<p>The DP6</p> <p>Small in size, large in performance. As a lavalier type and for panel mounting on control units etc.</p>
	<p>The GC/1 Cardioid</p> <p>For stage and church work, P.A. use, lecture halls etc., where acoustic feedback is a serious problem.</p>
	<p>The GR/1 and GR/2 Ribbon</p> <p>Ideal for studio and similar uses, when a high standard of fidelity is essential. Easily replaceable ribbon assembly.</p>
<p>Other models and a full range of stands, reflectors, windshields and accessories available</p> <p>All microphones are manufactured in a special section of our works, under strictly controlled conditions with stringent test and inspection at every stage. Each and every microphone is individually tested both aurally and on Bruel & Kjoer visual and graphic recording test equipment for conformity to a prescribed performance.</p>	

Grampian SOUND EQUIPMENT
Integrity that you hear

Send for leaflet giving full details

GRAMPIAN REPRODUCERS LTD.,
Hanworth Trading Estate, Feltham, Middlesex. 01-894-9141

whatever the make...

4-TRACK STEREO MONO

	Deposit £ s. d.	12 Monthly Payments £ s. d.	Cash Price Gns.
Philips EL 3312	14 15 0	3 11 8	55
Ferguson 3232	18 2 3	4 10 7	69
Sony TC200	18 18 0	4 14 6	72
Philips EL3555	19 13 9	4 18 6	75
Akai 1710	20 14 9	5 3 9	79
Tandberg 74	24 8 3	6 2 1	93
Philips 4408	24 18 9	6 4 9	95
Sony TC260	25 9 3	6 7 4	97
Tandberg Series 12	27 11 3	6 17 10	105
Revox 736 2- or 4-T.	31 4 9	7 18 2	119
Sony TC530	31 12 6	7 18 2	120
Akai M8	32 16 3	8 4 1	125
Beocord 2000K DeLuxe	32 16 3	8 4 1	125
Beocord 2000T DeLuxe	33 17 3	8 9 4	129
Akai X300	48 11 3	12 2 10	185
Akai X355	62 14 9	15 3 9	239

4-TRACK MONAURAL

	Deposit £ s. d.	12 Monthly Payments £ s. d.	Cash Price Gns.
Ferguson 3224	6 11 3	1 12 10	25
Fidelity Playtime 4	7 1 9	1 15 6	27
Fidelity Playmatic 4	8 2 9	2 0 9	31
Elizabethan LZ34	8 18 6	2 4 8	34
Ferguson 3218	8 18 6	2 4 8	34
Telefunken 201	8 18 6	2 4 8	34
Ferguson 3222	9 3 9	2 6 0	35
Philips EL4305	9 9 0	2 7 3	36
Grundig TK140	10 2 2	2 10 7	38½
Philips EL4306	11 0 6	2 15 2	42
Ferguson 3214	11 11 0	2 17 9	44
Truvox 44	12 6 9	3 1 9	47
Ferguson 3216	12 17 3	3 4 4	49
Tandberg 843	15 9 9	3 17 6	59
Philips EL3556	16 5 6	4 1 5	62
Truvox RI04	23 7 3	5 16 10	89

SPECIAL OFFER: SAVE £21



TELEFUNKEN 204 E

4-Track Stereo-Mono, Recording/Playback 3½, 7½ i.p.s.—Two 7" built-in speakers. Two 6 watts output stages. Transistorised Multi-play facilities. Brand New. Guaranteed. Current list price 106 gns.

OUR PRICE 86 gns.

£22.12.0 deposit and 12 monthly instalments of £5.12.10. Carriage and Packing free.

STEREO TAPE UNITS	Deposit	12 Monthly Payments	Cash Price
Sony TC250A	£ s. d. 14 19 3	£ s. d. 3 14 10	Gns. 57
Sony TC350	19 13 9	4 18 6	75
Beocord 1500 De Luxe	25 9 3	6 7 4	97
Truvox PD 102	27 11 3	6 17 10	105
Truvox PD 104	27 11 3	6 17 10	105
Tandberg 6X	28 17 6	7 4 5	110
Ferrograph 632	33 1 6	8 5 5	126
Ferrograph 634	34 12 6	8 13 4	132
Brenell STB.5'2'	37 10 0	9 7 6	£150

MAINS TWIN TRACK

Fidelity Playtime 2	6 11 3	1 12 10	25
Grundig TK120	U 7 14 11	1 18 9	29½
Philips EL3310	9 3 9	2 6 0	35
Grundig TK18L	9 3 9	2 6 0	35
Grundig TK125	10 7 6	2 11 10	39½
Truvox 42	12 6 9	3 1 9	47
Tandberg 82X	14 3 6	3 10 11	54
Tandberg 92	18 2 3	4 10 7	69
Brenell Mk. V3	19 8 6	4 17 2	74
Brenell Mk. V3 (Meter)	20 14 9	5 3 9	79
Truvox RI02	23 7 3	5 16 10	89
Brenell V/3 'M'	24 8 3	6 2 1	93
Ferrograph 631	24 18 9	6 4 9	95
Ferrograph 631/H	26 5 0	6 11 3	100

INTEREST FREE H.P. TERMS. OPEN SATURDAY 6 p.m. FRIDAY 6-30 p.m. IF UNABLE TO CALL WRITE FOR BROCHURES. PART EXCHANGES. 18 AND 24 MONTHLY TERMS ALSO AVAILABLE

THE RECORDER CO

(DEPT. R) 186-188 WEST END LANE, WEST HAMPSTEAD, LONDON, NW6

Telephone: 01-794 4977

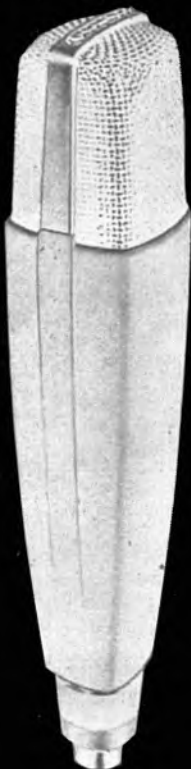

This is a technical ad...

Sennheiser

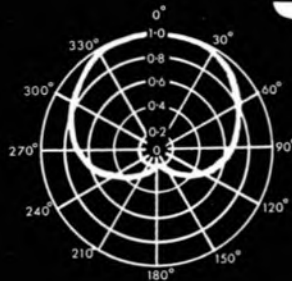

The MD 421 is just one example of technical perfection in Sennheiser's range of equipment. In design and manufacture all microphones receive the same expert care whether £6. dynamics, or £100 condensers. Although the MD 421 studio cardioid was designed for the professional, it is also used by over 50,000 amateurs.

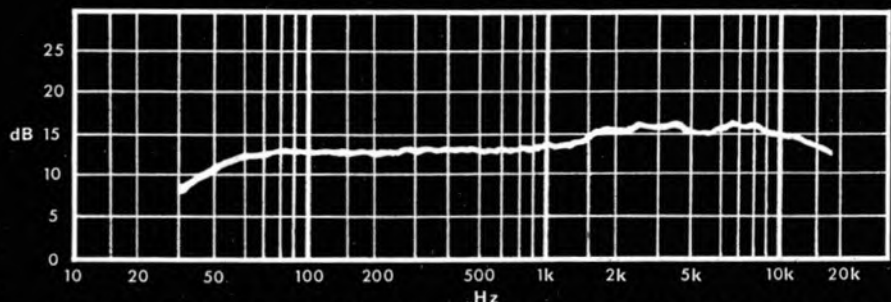

Audio Engineering Ltd 33 Endell St London WC2 836 0033

In this corner at 6lb. 8oz. the 'one spool wonder'

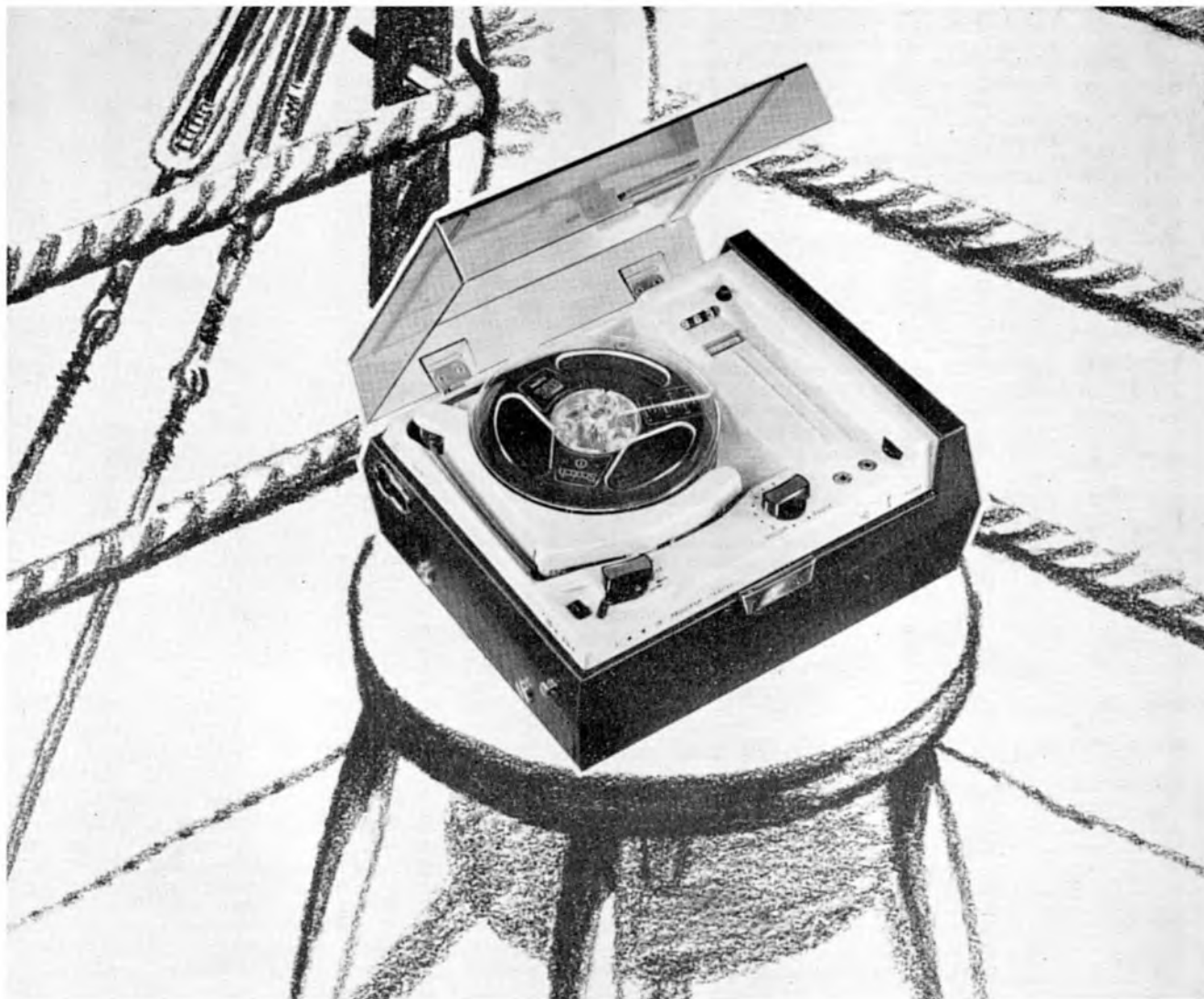

MULTICORDER BY **RADIONETTE** 38 GNS.

world champion by 25 points

1. Up to 12 hours playing time on one 5" spool. 2. Instantaneous 4 channel selection without turning the tape. 3. Light and compact - weighs only 6½ lbs. 4. Gives choice of battery or mains operation. 5. Fully transistorised (8 transistors - 5 diodes). 6. 2 speeds - 1⅞" and 3⅜". 7. Vinylite covered wooden cabinet designed for superb sound reproduction. 8. Quality and reliability built-in by Radionette - Norway's leading manufacturers of radio, television and Hi-Fi equipment. 9. Frequency response ± 3db at 10,000 c.p.s. Wow 0.2% 1.3 watts output. No room for any more. Why not drop us a line and we'll tell you the other 16 points?



DENHAM & MORLEY LTD · Denmore House · 173/175 Cleveland St. London W.1 Tel : EUS 3656

GIFTS FOR AUDIO ENTHUSIASTS

or you may buy them for yourself



BIB RECORDING TAPE SPLICER

Invaluable for precise and easy splicing and editing of tapes and you can use those odd lengths of tape.

Bib Tape Splicer is chrome plated, complete with razor cutter. Used by the professional studios. 18/6.



MODEL 8 BIB WIRE STRIPPER & CUTTER

Strips flex and cable without nicking the wire and cuts wires cleanly.

Model 8 Bib Wire Stripper & Cutter is instantly adjusted for 8 gauges. 8/6. Model 3 is pre-set for any thickness. 4/-.



BIB INSTRUMENT CLEANER

Cleans record players, tape recorders, metal, plastic and glass. Anti-static and non-flammable. Bib Instrument Cleaner. 4oz. bot. 4/6.



BIB TAPE HEAD MAINTENANCE KIT

Saves repair costs, ensures better recording and reproduction of reel and cassette recorders. Bib Tape Head Maintenance Kit has 2 each applicator and Polisher tools, 10 Applicator & Polisher sticks. Double-ended brush, packet of tissues and bottle of Bib Instrument Cleaner in plastic wallet. 12/6. Replacements available.



BIB HOME ELECTRICIAN'S KIT

Electrical jobs are so easy if you have the Bib Home Electrician's Kit. In the plastic wallet are a Bib Model 8 Wire Stripper & Cutter, plastic insulating tape, plug size screwdriver, 5 and 15 amp. fuse wire, 3 Cable & Flex Shorteners and Ersin Multicore Tape Solder which melts with a match. 14/6.



SIZE 15

Solder easily plugs and cables with 5 - Core Ersin Multicore Solder.

Size 15 Dispenser contains 21 ft. of 60/40 22 s.w.g. solder. 3/-.



BIB FLEX SHORTENER

Shorten without cutting, audio cables and flexes. Packet of 4 Bib Flex Shorteners 2/6.

All prices are recommended retail. Obtainable from most audio stockists. If in difficulty send cash with 2/- for postage and packing for orders less than 10/- and 2/6 for orders above 10/- (U.K. only) to: Bib Division, Multicore Solders Ltd., Hemel Hempstead, Herts.

FRANCIS OF STREATHAM

EVERYTHING ADVERTISED IN STOCK

MAINS RECORDERS

AMPEX 753 professional Stereo Deck and Pre-amp. Transistorised. 3 speed, 4 Track. (Mics. extra) 91
A special from Francis. gns.

Ampex 800 Series Stereo
Ampex 1100 Stereo
Ampex 2100 Stereo
*Akai 1710 Stereo
*Akai X-300 Stereo
*Akai 910 Mono
*Akai M.8 Stereo
*Akai 355 Stereo
*Beocord 2000 de luxe Stereo
*Beocord 1500 de luxe Stereo
*Brenell STB2 Stereo
*Brenell Mk.5/M Series/III M.
*Brenell Mk.5/M Series/III Mono
*Ferrograph 633 Prof. Mono
Ferguson 3230 Mono
Ferguson 3224 Mono
Ferguson 3232 Stereo 4 Tr.
*Ferrograph 631 Mono 2 Track
*Ferrograph 632/4 Stereo
Fidelity Playtime 2 or 4 Tr. M.
*Grundig TK245 S/M pre-amp
*Grundig TK340 Stereo
Grundig TK140 4 Tr. M 3 1/2
Grundig TK120 2 Tr. M 3 1/2
Grundig TK145 Auto 4 Tr. M
Philips Cassette 3312 Stereo
Philips 3310 Cassette Mono
Philips 3575 St. 3 sp. 4 Track
Philips 3576 M 4 Track 3 sp.
Philips 4306 2 sp. 4 Tr. Auto M.
Philips 4305 4 Tr. 2 sp. Mono
*Philips 4408 Pro. 3 sp. 4 Tr. St.
*Revox 736 2/4 Tr. 2 sp. Stereo
*Revox 77 Stereo Transistor

Sanyo 929 4 Tr. 2 sp. St.
Sanyo 939 4 Tr. 2 sp. St.
*Sanyo 999 3 sp. 4 Tr. St.
(Speakers extra)
*Sanyo 800 3 sp. 4 Tr. St.
PA/Deck
Stella 462 Mono 4 Tr. 4 sp.
Stella 463 Mono 4 Tr. 2 speed
Stella Mains/Batt. Cassette
*Tandberg Ser. 6X St. PA & DK
*Tandberg Ser. 12 St. 3 sp. 2/4 Tr
*Tandberg Ser. 8 St. 2 sp. 2/4 Tr
*Tandberg Ser. 9 M 3 sp. 2/4 Tr.
Telefunken 200 Mono
*Telefunken 204 St. 4 Tr. 2 Sp.
Telefunken 203 Ser. 50 M2/4 Tr.
Telefunken 201 Mono 4 Track
Truvox 50 Series M 3 sp.
Truvox R102 or R104 Mono
*Truvox PD102 or PD104 St.
*Uher Hi-Fi Spec. St. PA/DK
2 speed 4 Track
*Uher Royal St. 4 sp. 4 Tr.
Ultra 6212 Mono 4 Tr. 3 sp.
*Vortexion WVA 3 sp. 2 Tr. M.
*Vortexion WVB 3 sp. 2 Tr. M.
*Vortexion CBL 3 sp. 2 Tr. St.
*Wyndor Vanguard 3sp. 4 Tr. M

BATTERY MODELS
Akai X-IV 4 Tr. Stereo
Loewe Opta 416 2 Tr. 2 sp. B/M
Loewe Opta 450 Cassette B/M
Philips EL3302 Cassette
Philips 4200
Sharp Batt/Mains 2 Tr. 2 sp. M
Sony TC800 2 Tr. 2 sp. M. B/M
Stella 473 Cassette
Telefunken 300 2 Tr. Mono
Telefunken 302 4 Tr. 2 sp. M
Uher 4000L 4 Tr. 2 sp. Mono
*Uher 4200/4400 2 sp. St.
*Microphones extra

FOR A FAIR DEAL AND HONEST SERVICE

- ★ Minimum Deposit and no Interest or Service Charges on H.P. up to 18 months.
- ★ Free Service during Guaranteed Period.

SPECIAL TAPE OFFER

Brand new Shamrock Tape. Top quality. Guaranteed.
2,400; 7" spool ... 25/-
1,800; 7" ... 21/-
1,200 7" or 5 1/2" or 5" ... 15/-
900; 5" ... 12/6
600; 5" ... 10/-
PIP 1/6 per reel. Orders for £3 or more sent post free.

MICROPHONES, MIXERS

Hammond Condenser M100
Grampian Reflector
Grampian DP/4 Dynamic
Reslo Ribbon
AKG D.19C
Eagle Mixer
Hammond 5-way Mixer
AKG K.50 Headphones
Philips Pre-amp
Microphones by ACOS, TELEFUNKEN, BEYER, FILM INDUSTRIES, also STANDS, BOOMS, etc.

MAINS POWER PACKS

Philips, Stella or Cossor
Telefunken 300 with cell
Uher 4000, with cell
PRE-RECORDED TAPES & CASSETTES by Columbia, H.M.V. and E.M.I. Bib and E.M.I. splicers. Matching transformers. Defluxers, etc., etc.

Hi-Fi Dept.

- **AMPLIFIERS**
Quad Rogers Leak Armstrong
Tripleton Scott Truvox Nikko
Goodman Ferguson Philips
Arena Sinclair Tandberg
"Huldra"
- **TUNERS**
Quad Rogers Philips Leak
Armstrong Tripleton Arena
Nikko Arena Tandberg
"Huldra"
- **LOUDSPEAKERS**
Quad Rogers W.B. Kef
Wharfedale Goodman Tannoy
Lowther Leak Elac Truvox
Ditton Philips
- **MOTORS, PICKUPS**
Garrard incl. Thorens
SP.25 401, etc. Tannoy
Goldring Shure
Connoisseur Empire
Philips Sonotone
Decca Deram SME Mk. II
BSR
Ortofon BSR
Dual Pickering
Euphonic
All types of Diamond and Sapphire
styli, stereo and mono, Microlifts,
Garrard, Goldring and Acos Pressure
Gauges, Disc Preener, Acos Dust Bug.
- **CABINETS** by Record Housing
Clearview and G.K.D.

169-173 STREATHAM HIGH ROAD, LONDON, S.W.16

Between St. Leonard's Church
and Streatham Station

01-769 0466/0192

Please note this is our only address ● Free Car Park in Prentis Rd.—2 mins. away
OPEN ALL DAY SATURDAY—EARLY CLOSING WEDNESDAY

Sanyo puts you in the world class



Introducing the new MR 939 recorder with these outstanding features

- 7 watts per channel
- 4 tracks, 3 speeds
- Sound on sound
- Sound with sound
- Built-in public address system

Tape speeds
7½ ips (19 cm/sec)
3¾ ips (9.5 cm/sec)
1½ ips (4.8 cm/sec)
Wow and flutter
7½ ips: 0.15% R.M.S.
3¾ ips: 0.20% R.M.S.
1½ ips: 0.30% R.M.S.
Recording time
96 min at 7½ ips
(Stereo 1200ft. tape)
192 min at 3¾ ips
(Stereo 1200ft. tape)
384 min at 1½ ips
(Stereo 1200ft. tape)
Signal-to-noise ratio
45 db

Output power
Music power 7W x 2
Undistorted 4W x 2

Frequency response
7½ ips 20-20,000 c/s
(30-15kc ± 3db)
3¾ ips 30-13,000 c/s
1½ ips 30-8,000 c/s

Erase rate
65 db

Crosstalk
50 db (channel-channel)
65 db (track-track)

Output impedance:
Line out: 2 Kohm

Speaker out: 8 ohm
Headphone: 10 Kohm

Input impedance
Microphone: 50 Kohm
Aux: 100 Kohm

Weight
26.3 lbs (16.5 kg)

Accessories
Microphone x 2
Recording tape 7" x 1
Empty reel 7" x 1
Patch cord x 2
Reel stopper x 2
Splicing tape x 1
Microphone stand x 2
Price: about 89 guineas

SANYO

RELIABILITY IS BUILT IN

—Vortexion

12-WAY ELECTRONIC MIXER

quality equipment

The 12-way electronic mixer has facilities for mixing 12 balanced line microphones. Each of the 12 lines has its own potted metal shielded microphone transformer and input valve, each control is hermetically sealed. Muting switches are normally fitted on each channel and the unit is fed from its own metal shielded mains transformer and metal rectifier.

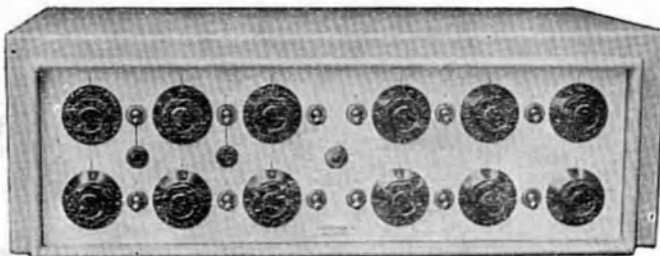

FOUR-WAY ELECTRONIC MIXER

This unit provides for 4 independent channels electronically mixed without "spurious break through," microphone hum and background noise have been reduced to a minimum by careful selection of components. The standard 15-50 ohm shielded transformers on each input are arranged for balanced line, and have screened primaries to prevent H.F. transfer when used on long lines.

The standard 5 valve unit only consumes 18.5 watts. H.T. is provided by a selenium rectifier fed by a low loss, low-field transformer in a screening box. The ventilated case gives negligible temperature rise with this low consumption assuring continuance of low noise figures.

20,000 ohms is the standard output impedance, but the noise pick-up on the output lines is equivalent to approximately 2,000 ohms due to the large amount of negative feedback used.

For any output impedance between 20,000 ohms and infinity half a volt output is available. Special models can be supplied for 600 ohms at equivalent voltage by an additional transformer or 1 milliwatt 600 ohms by additional transformer and valve.

The white engraved front panel permits of temporary pencil notes being made, and these may be easily erased when required. The standard input is balanced line by means of 2 point jack sockets at the front, but alternative 3 point connectors may be obtained to order at the rear.

Mixer for 200-250 V AC Mains	£40 8 6
Extra for 600 ohm output model	£1 18 6
Extra for 600 ohm 1 milliwatt output	£3 0 6
Size 18½ in. wide × 11½ in. front to back (excluding plugs) × 6½ in. high.	Weight 22 lb.			

THREE-WAY MIXER and peak programme meter for recording and large sound installations etc.

This is similar in dimension to the 4-Way Mixer but has an output meter indicating transient peaks by means of a valve voltmeter with a 1 second time constant in its grid circuit.

The meter is calibrated in dB's, zero dB being 1 milliwatt-600 ohm (.775 V) and markings are provided for +10 dB and -26 dB. A switch is provided for checking the calibration. A valve is used for stabilising the gain of this unit. The output is 1 milliwatt on 600 ohms for zero level up to +12 dB maximum. An internal switch connects the output for balance, unbalance, or float. This output is given for input for 40 microvolts on 15 ohm.

An additional input marked "Ext. Mxr." will accept the output of the 4-Way Mixer converting the unit into a 7-Way controlled unit. This input will also accept the output of a crystal pick-up but no control of volume is available.

The standard input is balanced line by means of 3 point jack sockets at rear but alternative 2 point connectors may be obtained to order at the front or rear as desired.

The 8 valves and selenium rectifier draw a total of 25 watts.

P.P.M. for 200-250 V AC Mains	Price on application
Size 18½ in. wide × 11½ in. front to back (excluding plugs) × 6½ in. high.	Weight 23 lb.		
10/15 watt Amplifier with built-in mixers.			
30/50 watt Amplifier with built-in mixers.			
2 × 5-way stereo mixers with outputs for echo chambers, etc.			

Full details and prices on request.

VORTEXION LIMITED, 257-263 The Broadway, Wimbledon, S.W.19

Telephone: LIBerty 2814 and 6242-3-4

Telegrams: "Vortexion London, S.W.19"

now hike mike's got company...

...these 5 newcomers to the Audac range of integrated microphone transmitters

Transmitter Type TX/65

for use in highest quality sound systems. Versatile in operation, general purpose use in entertainment industry.



Hike Mike fitted with windshield and 'pop' filter

top quality, all purpose, omni-directional.



High power separate transmitter

unit for professional use where an individual choice of microphone is required. Reliable and trouble-free operation up to 1/4 mile distance.



Transmitter Type TX/45

ideal for the solo entertainer. Uni-directional properties make it most suitable for operation in most difficult acoustic conditions.



Transmitter Type TX/C

Same characteristics as Hike Mike, shape allows either hand or lavalier operation. General purpose.



Like Hike Mike each is completely cordless, contained in one neat unit, no bigger, no heavier than a torch. No following flex, no bulging pocket transmitter

AUDAC RADIO MICROPHONE AND SOUND REINFORCEMENT SYSTEMS

AUDAC MARKETING COMPANY LTD/FOREST WORKS/CAREY RD/WAREHAM/DORSET/Tel: Wareham 2245

TAPE

RECORDING
MAGAZINE

Incorporating Tape Recording & Hi-Fi Magazine,
and Stereo Sound Magazine

Vol. 12 No. 3 March 1968

IN THIS ISSUE

Tape trends and tape talk	110
Douglas Brown	
Techniques—FAMILY RECORDS	111
Denys Killick	
THREE THOUSAND MILES BY TRAIN	112
Douglas Brown	
THE HOME STUDIO	116
John Borwick	
GIVE A DOG A BONE!	118
Basil Dawson	
HIGH ADVENTURE	120
Denis Gilbert	
THE FINE ART OF MULTI-TRACK	122
Test Bench—AKAI 3000-D	124
Musicassette Reviews	126
NATURE NOTES	127
Richard Margoschis	
Cross Talk	128
By Audios	
3 3/4 ips Mono Reviews	131
7 1/2 ips Stereo Reviews	132
Advertisement Inquiries Service	137

COVER PHOTOGRAPH: One of the countries figuring prominently in the news is Mauritius, a colony that is about to acquire the status of an independent State. Here we see a member of the staff of the Mauritius Broadcasting Corporation interviewing a local personality in the little Mauritian village of Deep River. The equipment slung on her shoulder is just out of shot—in fact it is the ubiquitous Uher 4000 Report-L, an instrument favoured by interviewers throughout the world. The picture was taken by John Cordeaux who is now busily engaged in our own local broadcasting service.

"TAPE Recording Magazine" is published on the third Wednesday in the month, by Print and Press Services Ltd., from Prestige House, 14/18 Holborn, London, E.C.1.

"TAPE Recording Magazine" is available by a postal subscription of 25s per annum (U.S.A. \$3.75) including postage, or it can be obtained at newsagents, bookstalls and radio and music dealers. In the event of difficulty, write to the Publishers at Prestige House, 14/18 Holborn, London, E.C.1.
Back numbers, if still in print, are available, at 2s. 6d. per copy.

Address all communications

PRESTIGE HOUSE,
14/18 HOLBORN, LONDON, E.C.1

EDITORIAL

01-242 4742

Publisher,
R. DOUGLAS BROWN

ADVERTISING

01-242 4851

Editor,
DENYS G. KILLICK

Advertisement Manager, VIVIENNE GOODING

Tape trends and tape talk

By Douglas Brown

OVER THE YEARS, *TAPE Recording Magazine* has several times made market surveys of its readership and one fact which has clearly emerged is that a high proportion of the serious recording amateurs who buy this publication are men in the 25 to 40 age range. Teenagers and women are both comparatively small minority readerships.

In the past, when these surveys were made, this probably reflected accurately enough the pattern of recorder usage in this country. But the fall in prices of popular recorders, and particularly the appearance of the cassette machines, has undoubtedly changed the picture dramatically.

The trend was shown up in a poll of home entertainment habits taken not long ago by an American teenage magazine called *Seventeen*. Its remarkable finding: that more than 12 million American girls between 13 and 19 spend a quarter of their time listening to radio, TV, disc or tape programmes—and that 22.2 per cent of the girls polled own their own tape recorders.

Taking the American population as a whole, about 8 per cent are believed to have tape equipment in their homes, so the teenage girls now appear as nearly three times as keen on tape as their elders.

On this basis, the U.S. pollsters forecast that teenage girls will buy 800,000 recorders during 1968. The same poll turned up evidence that few of them know how to use the recorders *as recorders*—creatively; but that is true, of course, of all age groups, everywhere.

* * *

THE FIERCE FIGHTING which flared up recently in Vietnam showed, among other things, the development of the craft of war reporting. The radio correspondents were operating very close to the front line, sometimes collecting bullets as well as very remarkable photographs *and sounds* from the fighting zones.

Until very recently sound tracks were added later to this type of news-film. Now filming and recording have been simultaneous, and, in my view, it has made an enormous difference. There is an immediacy, a sense of presence, which brings the realities of battle into every viewer's sitting room.

Already this involvement of Everyman is having important political repercussions. No longer does the electorate wait upon delayed travellers' tales; it watches and listens to events within hours of their occurrence. This can be uncomfortable for those in authority, as President Johnson now knows.

And the process has not, by any means, yet run its full course. When there is an adequate "grid" of relay satellites up above and when the cameras use magnetic tape instead of photographic film (which has to be processed) it will become quite

literally possible for a world audience to see and hear events anywhere *as they are occurring*. It is difficult to believe that that will not have a profound effect upon international diplomacy and national politics.

P.S. The quality of most of the sound recording from the Vietnam battles was excellent and a tribute to the operators. But I heard one tape which had obviously been recorded on a machine with batteries going flat. Once the war correspondent went to work using only an observant eye; now he needs cans of film, spools of tape, spare batteries. . . .

* * *

A FEW MONTHS AGO one of Britain's tape recording magazines changed its identity; though it keeps an eye on what's afoot in our particular world of tape, its gaze is now concentrated on a much wider field.

More recently a second tape recording magazine has increased its price, as is very understandable in view of the alarming recent increase in the costs of magazine production. It now costs 25 per cent more than does *TAPE Recording Magazine*.

We are left, therefore, as the only magazine which provides a complete and authoritative coverage of all tape recording matters for two shillings a month.

We shall maintain this price for as long as possible, as our contribution to the current national effort to hold down prices and improve overall economic performance. Happily, manufacturers and traders recognise the unique standing of this magazine and the available indication of the advertising backing we may expect from them in the months ahead enables us to say now that there is unlikely to be any increase in the selling price of *TAPE Recording Magazine* for at least six months.

If you know anyone who has recently bought a recorder and who needs guidance on the hobby, now is the time to introduce him (or her) to *TAPE Recording* and to make him (or her) a regular reader.

* * *

THE TAPES entered in the British Amateur Tape Recording Contest are being sifted and the final judging takes place towards the end of March. The actual prize-giving will be staged, this time, at the International Audio Festival and Fair in April.

The number of entries this year is well up on the last couple of years and slightly up on the best-ever total since the Contest was established in 1957. A trend which has been obvious in several recent Contests is confirmed: the growing popularity of music recording. Nearly a third of the entries come in this category.

Next most popular type of recording—but a long way behind—is documentary.

FAMILY RECORDS

BY DENYS KILLICK

IN recent editorials I have been discussing problems relating to creative recording activities. If those articles have been of some small help to only a few people then they will have been well worth while. But today I want to think about those enthusiasts whose interests are less concerned with creativity than with lighter amusement. For every one person who regards sound recording as a serious activity only to be undertaken with purposeful dedication there are hundreds whose devotion is limited to the kind of work that many a purist would scorn.

How many tape recorder owners never engage in any more ambitious project than dubbing off the air? I suspect a very great many; and if this gives them pleasure and if they have no desire to become more involved then why should they not find their pleasure in this way? All the lower cost tape recorders (there probably are exceptions but I can't think of them) are offered for sale complete with a microphone of some kind. Few of these microphones will be used for serious recording work; the vast majority will never do more than pick up the sounds of Baby's first words, or other homely effects.

Generalisations are usually dangerous, but one can suggest with reasonable safety that modern domestic recording equipment at any price level is capable, in terms of quality, of undertaking better things. And yet what things can be better than those applications that give real pleasure to the owner, even if they are "strictly for amusement?" When equipment is used only in this lighthearted or superficial manner one can obtain far more pleasure and enjoyment by adopting some of the disciplines and techniques that have been discussed in this series—the mistake made by far too many people is the adoption of the attitude that because recordings are taken for no other reason than passing amusement there is no need to bother.

Take just one example, Baby's first words. These were probably recorded in a spare half-hour one Saturday or Sunday afternoon. During the following weeks



Who could resist him? A cassette machine is being used here to make a permanent record of the delightful moments of extreme youth

they were played over proudly to friends and relations. Then the tape was put on one side and when we last wondered vaguely where it might be we had a nasty feeling that it was probably erased when a tape was slapped on the machine in a hurry to record a live Beatles broadcast. In a few months' time Baby's voice and vocabulary will have changed. An irreplaceable record has gone for ever.

This kind of situation can be easily avoided. Just one 7 inch spool of tape does not cost so very much. It should be bought and then permanently marked on both the box and the spool with the words, "Family Records." On this tape can be recorded any sounds of interest, remembering that even one's own voice as heard in 1968 could be a cherished possession for someone in the year 2000.

Too little is thought of the sounds we hear all the time because we are too

familiar with them. Just because tape can be erased so easily one tends to overlook the *permanence* of the medium. Our tape entitled "Family Records" should not be produced and played back to casual visitors. They will be bored to tears with it, just as they would be bored with wading through a family snapshot album. Forget all about playing it back; just concentrate on recording more and more episodes. When the tape is full mark it Volume 1 and start Volume 2.

In compiling such a record we can forget all pretensions to artistic presentation. Because interest is limited to the immediate family we do not have to worry about outside criticism. Its value lies in its content, not in production.

Once we accept the permanence of magnetic tape as a recording medium we

Please turn to page 114

THREE THOUSAND MILES BY TRAIN—WITH A RECORDER OF COURSE!

THE STORY OF AN EPIC JOURNEY BY DOUGLAS BROWN



The Super-Continental makes its way through the breath-taking scenery of the Jasper National Park against a panoramic background of mountain peaks

A TRAIN journey is a good subject for a sound documentary. There distinctive and characteristic sounds to record; there is the constantly changing scene to describe; there is a good supply of people to interview, most of them with time on their hands.

There is probably no better train journey in the world to handle in this way that between Vancouver, on the Pacific coast, and Montreal, in eastern Canada. It is almost 3,000 miles and it takes in the Rocky Mountains, the great prairies, and the forests and lakes of Ontario. Appropriately, one of the crack trains which makes this journey is called the Super-Continental.

It was on the Super-Continental that I rode out of Vancouver one afternoon last August.

Perhaps I am a little emotional about trains. I regard them (with ships) as the most civilised means of transport. I have ridden in trains from Kiruna, well inside the Arctic Circle, to Naples, on the blue Mediterranean; from Ostend to Vienna, from the Hook of Holland to Moscow

and Leningrad. But the journey across Canada was the longest and most exciting of all my trips by train.

It was imperative, therefore, that I record it. But to do so was clearly going to be a big operation. I recognised from the outset that I needed to make fairly elaborate arrangements in advance; I therefore contacted the Canadian National Railways and asked for introductions to be made when I arrived in Vancouver and at various points across the country. Where these special contacts were made, they proved invaluable; in one or two cases where circumstances upset the plans, the consequences were serious—I missed the particular recordings I had wanted.

Thinking about the project in advance, I felt the best approach would be a sound montage of the impressions of a representative collection of passengers as the Canadian countryside flowed by. I would find myself perhaps half-a-dozen people on the train and record them all at intervals—as we gazed on Mount Robson, the highest peak in the Rockies; as we first caught sight of Winnipeg; as we ran through the woodlands of Algonquin Park; and so on.

Between times I would collect the obvious sound effects: train starting, running at speed, stopping; locomotive bell and siren; station announcements. Then, back home, I would be able to link all this material together with a descriptive commentary.

Once I had completed the journey, I still felt this would have been the best way to compile a documentary, but unfortunately I had failed to collect as much material as I had hoped. There were two reasons for this.

The first was the fact that some of the advance planning failed to produce desired results. Most seriously, my contact man in Vancouver had suddenly to rush off to a conference several hundred miles away and was not available to make introductions and generally to smooth away problems before the actual journey commenced. This meant, for example, that I was not able to get a satisfactory recording of the announcement of the train departure from Vancouver; the recording I made in the station concourse lacks a satisfactory balance between announcer's voice and background noise. I needed to have set up specially an announcement from a quieter spot in the station concourse, which I could have recorded direct (and possibly have added reverberation later) instead of taking through the station's PA equipment. Among the other preoccupations of departure on a journey of this kind, I simply could not cope with the organisation

required, simple as it now seems in retrospect.

And this leads me to the second reason why I did not get all the material I had hoped for. On a job like this it is virtually a whole-time occupation to record; but I was on holiday, and accompanied by my wife. Was I to forego the pre-dinner drink and relaxed conversation in the comfortable lounge-bar coach; to carry my recorder to every meal and record snippets between the courses; to ignore the superb scenic panoramas myself in order to collect the impressions of other people? I tried to compromise; so I enjoyed the trip as a holiday, but I did not make the most of it as a sound recording assignment.

A word now about the equipment. I borrowed, from the English agents, Bosch Ltd., a new Uher 4000 Report-L. It was a machine which I was well used to—it is used for most BBC reporting these days and I had frequently drawn models from their stock for specific assignments. Acceptance by the BBC is all that needs to be said about the quality of the recording on this machine. In its strong (and handsome) leather carrying case it is easy to carry and to operate in almost any environment.

The case proved itself on one occasion when, invited to ride on the locomotive footplate of the Super Continental, I had to do some vigorous stretching to climb aboard and the recorder swung from shoulder and struck a steel step. Once in the engineer's cab I tried to record—and nothing happened! I opened up, found no visual damage, pressed the batteries home in their compartment, and tried again and everything was perfect. A severe blow against heavy metal had slightly displaced a battery, but had no other effect.

The 4000 Report-L operates at four speeds, but I used only the two faster: 7½ and 3¾ ips, selecting according to the material I was recording. To sum up, the recorder behaved perfectly, my opinion of it was greatly enhanced, and henceforth I think I cannot afford to be without a Uher 4000-L always available at a moment's notice.

The Super Continental left Vancouver at 17.15 in the afternoon, and by the time we had settled in our compartment (called, more appropriately, a bedroom—my wife and I had it to ourselves, with two armchairs during the days, two bunks during the nights, and our own private washbasin and WC) and unpacked, we were running up into wild mountain country.

We chatted with the conductor in charge of our coach, we went along to the bar for a drink and met some of our fellow passengers, and then we went in to dinner. We were to be on board for three days and three nights, so I saw no need to rush into recording activity immediately; better to "settle in" gently and to get to know a few people.

At dinner we found ourselves sharing a table with a top official of the Red Cross movement in British Columbia and a member of the train crew—the "rear tailman." This was our introduction to Canadian democracy: a complete absence of artificial social barriers which was so refreshing and so sensible! The "rear tailman" was a fascinating character: he had been born at Kicking Horse Pass, in the Rockies, his grandfather had been a railwayman in the great pioneering days of the continent, and railways were in his blood.

This was a good start and, after dinner, I roamed the length of the train with microphone at the ready and collected good material. I recorded a lengthy interview with the train conductor in which he provided

me with all the desirable factual background: how the train was staffed, what were the duties of each member of the crew, the weight and make-up of the train, the nature of the route ("We have rock slides . . . Occasionally we have washouts . . . The track patrol man finds them before the train arrives and we are able to stop before coming up to the obstruction . . . All we have to do is to wait until the repairs are made.")

The conductor broke the news to me that, in the course of the journey across the country, the total crew involved on board the train (including the locomotive) was almost 100. That was the end of any pretensions I had to interview them all.

The next morning we were up soon after 05.00 and I was recording immediately ("The scenery outside: fairly high hills—we're very high up now—thickly clad in firs, and in the distance more rugged mountains with pockets of snow shining in the sun.")

At 07.45, fourteen hours out from Vancouver, the train was stopped for five minutes beneath Mount Robson, highest peak in the Canadian Rockies, so that we could enjoy the superb scenery.

Once we were through the Rockies I went up into the Vistadome car—a coach hooded almost entirely in glass, from which one could have an uninterrupted view in every direction. There was a group of youngsters en route to Expo in Montreal, laughing and chatting. One of them played bagpipes. The whole thing made a nice sound sequence on tape.

At lunch I recorded the dining car steward ("Most of the passengers I never see again. There are about two dozen people I've seen perhaps three or four times—that's quite nice, we're like old friends because we've met before. But if I'm seeing someone for only one trip, I try to be friendly; then they remember me as a happy person. Sometimes I'm miserable, but I can't help that . . .")

So it went on: interviews, with train crew and with passengers; train noises collected whenever possible; my own impressions recorded directly on to the tape, with the background rhythm of the train wheels, at regular intervals ("We've stopped at Edmonton, capital of Alberta. The temperature is 83; the sun is blazing down. Along the platform little trucks are delivering huge blocks of ice, which are being stored in compartments under each of the coaches. At the front end, the baggagemen are unloading and loading again and the locomotives are being changed.")

On the final day, as we ran across Ontario, I was invited to join the engineer and his second-in-command on the footplate. I had tried, in the past, to record on the footplate of a steam locomotive travelling at speed in Britain, and failed to achieve a satisfactory balance. With the Uher in Canada, I had no problem and this turned out one of the best sequences ("I'm riding in the first of three locomotives which are coupled together and all of which are controlled from the cab of the leading loco. We're running at a speed of about 55 miles an hour. It's very beautiful wooded country and the line has some quite sharp curves. Looking back from the locomotive cab, I can see 18 coaches curving away behind, a train with a total weight of well over 2,000 tons and carrying 450 passengers.")

On the footplate I collected the sounds of train hooter which had been almost inaudible in the sealed, air-conditioned coaches behind; and some very interesting comments from the veteran engineer.

So I came back to England with several hours of recordings and set to work to sort

them out. I started by typing out *in full* everything that I had on the tapes; and I mean everything, repetitions, verbal stumbles, and all. Unless you have a full transcript it is impossible to do the thorough editing on paper which should precede the editing on tape.

The typing of this material also served to make me very familiar with the content. I listed on paper the principal constituents available to me:

Interviews: Train conductor—basic facts about trains, etc.

Dining steward—impressions of passengers, etc.

Locomotive engineer—details of route, etc.

Computer salesman—passenger's impressions. . . .

FX: Train wheels rhythm.

Locomotive bell.

Locomotive hooter.

Brakes being applied.

Crowd noise at Vancouver at departure.

Boy passenger playing bagpipes . . .

. . . and so on.

I was then able to settle on some basic themes for my finished tape:

Description of the train.

Meeting the crew.

Introducing some passengers.

The railway line and its history.

The Canadian scenery.

Eating and sleeping on a continental train . . .

and so on.

I did a lot of thinking and pondering as I did this paper work and, eventually, by a natural evolutionary process, I found the shape of the programme emerging. I then felt ready to start scripting. The best thing I can do here is to quote the opening passage of the script:

TAPE—FX: Blasts on train hooter, with running noises (FADE).

Commentator: The Super-Continental, one of the last great romantic trains in the world, a 2,000-ton monster of gleaming silver and blue, snaking its way almost 3,000 miles over the Rocky Mountains and through the great prairies and among the forests and lakes of the Canadian continent. Out of the Central Station in Montreal every afternoon at 16.15 hours . . . promptly, to begin the westward run; out of Vancouver, British Columbia, at 17.15 hours every afternoon . . . promptly, for the eastward run. Three days and three nights later each train completes its journey . . . usually dead on time. At any given moment, there are three Super-Continentials running in each direction, with 24-hour intervals between them. Why do people, in this day and age, choose to make such enormous journeys by train?

TAPE—Laurence Painter: Well, it's necessary for me to fly quite a lot in my business and when I get on a vacation, I like the relaxation and the contacts of train travel. I enjoy the meals and the whole relaxed atmosphere. No telephone. No television. Nothing to distract you from just enjoying yourself.

TAPE—Phil Leaves: There's always something new to see. There's always a beautiful waterfall, or the peaks with the snow. There's always something different to see. It's always pretty.

TAPE—FX: Blasts on train hooter, with running noises.

Commentator: The old Orient Express, swaying down through Central Europe and the Balkans, was made by the novelists a train of mystery and excitement. The train which today runs from the North Sea, at the Hook of Holland, across Northern

Please turn to page 114

FAMILY RECORDS

Continued from page 111

are led into all manner of interesting conjectures. Our family record is not only intended for our own interest and amusement in the years to come, but also for future generations. We have only to think what our reaction might be today to the sound of our great-great-grandparents' voices to realise how significant these recordings will be to our great-great-grandchildren. Even if for no other reason family records should be carefully prepared and preserved.

Dubbing music from the air is so easy that one tends to think little about it. "Recorded today—erased tomorrow" is a happy-go-lucky philosophy that certainly brings a little pleasure but cannot possibly offer the satisfaction that a collection of good recordings will bring to the more careful owner. The enemy is the erase head. If tapes could not be erased we should be far more careful what we recorded.

Too often recordings are wiped out merely to make space for items in which there is only a passing interest. These, too, are destined for early destruction. By carrying on in this way one can certainly do quite a lot of recording throughout the year, but at the end of that time there is very little indeed to show for it. Did you ever come across anyone owning a gramophone with only one disc to play? Such a thought is too ludicrous for words, and yet there must be many recorder owners who use their equipment for amusement and yet who only possess a single spool of tape. If we don't buy tape we are not using the machine properly.

Naturally cost enters into this, but a close comparison shows that magnetic tape does not compare unfavourably to the cost of gramophone discs. If we take the very cheapest records we can buy (at about 12s. 6d. each for a 12-inch LP) we find that the actual cost is in the region of 3½d. per minute's playing time. A well-known branded make of recording tape costs 47s. for a 7-inch spool of long play, 1,800 feet, which gives 90 minutes programme time per track at 3½ ips. This works out to about 3½ pence per minute if we are working either half-track mono or quarter-track stereo, or about 1½d. per minute if we are recording quarter-track mono. I have purposely used for my comparison one of the cheapest gramophone labels and have compared it to one of the best known branded recording tapes. The figures speak for themselves.

Music for personal entertainment at home will always cost less on tape than it will on disc. As it is illegal to copy broadcasts of gramophone records I must point out that we are not really comparing like with like. If we are law-abiding citizens our recordings will be of live broadcasts, but they will not be any the less enjoyable



Extreme youth gives way to—comparative—old age! These recordings will be highly treasured in the family archives

for that. A very great deal more pleasure will be obtained from our equipment if we make up our minds to spend just a little more on tape and then methodically index all the recordings we take.

When we select a gramophone record to play we know exactly what work we shall hear; there is not only a pretty picture on the front of the sleeve, but there is probably also a descriptive splurge on the rear. If we ignore both of those there is a label in the centre that tells us precisely the programme content. It is this basic programme information that is lacking in far too many tape boxes. Recordings are taken, put away and forgotten, and then inevitably erased.

An index system need not be complicated. Some people object to writing on the rear of the tape box because they regard this as being too permanent. If the tape should ever be erased then that information will be wrong. The problem can be solved by buying a 6d. packet of

plain postcards. Rule them up to allow for the insertion of a date, position indicator reference and title. One card per box is all we need. As the tape library grows a loose leaf cross index can be opened, and this will enable the owner to go directly to any item he wishes to hear. Some systems of indexing are so complex as to require a mathematical genius to cope with them. This is as wrong as it is unnecessary. The more simple the index the more it will be used. The most primitive index in the world is a thousand times better than no index at all.

My suggestions this month may appear to be so simple and so basic as not to warrant attention at all. But they do form the basis of logical recording activities and even if we record for no reason other than light-hearted amusement there is no reason why our activities should not be so arranged as to give us the best possible return for both the time and the money spent.

3,000 MILES BY TRAIN

Continued from page 113

Europe into the heart of Communist lands and eventually deposits one at the Byelorussian station in Moscow, still carries an aura of hazard and intrigue. But the Canadian Super-Continental: it is an open train, as Canada is an open country; a friendly train, a holiday train. When you climb aboard and settle into your compartment, it's more like the start of a cruise than of any ordinary train ride. For three days and three nights you are going to be members of the train community. . . .

Once I have got that far with a script, I find the rest flows fairly easily. The Canadian trip will make me a good documentary of at least twenty minutes running time, and it

may merit up to half-an-hour. Anything more, even for a subject as big as this one, would be a mistake. Interest could not be sustained.

As is implicit in the last paragraph, I have still not completed the making of my tape documentary. But, with a detailed working script, I regard the difficult part as done; the actual re-recording and mixing and fading and cutting and splicing can be done at leisure over the next few months. My impressions may fade, but the essential things are now on paper or on tape. I shall be satisfied if, among the distractions of a fairly hectic life, I can manage to complete my most ambitious tape documentary to date in time to enjoy its playback during next winter's dark evenings.

**EMITAPE is not just
the finest recording tape
backed by the world's largest
recording company....**

**EMITAPE is also completely
British manufactured.**



EMI's exacting quality control ensures that you get perfect, clean recording results every time – there are four grades of Emitape in five reel sizes to suit all recording requirements.

And you have the satisfaction of knowing you're backing Britain by buying an all-British manufactured recording tape.

Don't buy any tape – buy EMITAPE



An EMI group product
EMI TAPE LIMITED, HAYES, MIDDLESEX, ENGLAND

In his third article of this series our author discusses the microphone

THE HOME STUDIO

By JOHN BORWICK

MICROPHONES for the home studio should be carefully chosen to line up with the objectives listed in Part One—good technical quality, consistency and versatility.

Crystal microphones are ruled out because their technical quality is limited—the response tends to rise to a peak around 5,000 Hz and then fall away—and they are affected by ambient temperature and humidity. Another drawback is that the crystal element corresponds to a capacitance of about 400-1,000 pF so that low capacity cable has to be used and even then every foot of cable run reduces the strength of signal reaching the tape recorder.

In practice, this limits cable lengths for crystal microphones (and other high impedance types) to a few feet. This would make it impossible to instal the tape recorder in a separate room from the microphone and often means that the mechanical noise of the recorder is picked up by the microphone and forms an annoying background to all recordings.

Readers who possess a simple recorder with a matching crystal microphone may despair at this point. But they should take heart: many of the other topics in this series will interest them. A home studio relies on many things besides the basic equipment. In any case, depending on the input sensitivity rating of your recorder, it may be that you can use one of the low impedance microphones described below, with a step-up transformer or small booster amplifier at the recorder end of a long cable.

Low impedance microphones

The co-axial cables used for microphones, like those for TV aeriels, have a low characteristic impedance. This means that a source of *low impedance* (25-50 ohms) or *line impedance* (200-600 ohms) may be used with 100 feet or more of cable without loss—provided that the same terminating impedance is used. Professional recorders, mixers and consoles therefore tend to standardise on low or line impedance inputs (and outputs) and microphones are rated accordingly. Sometimes, as on the Ferrograph, the recorder inputs will be at high impedance but low impedance microphones are recommended and a suitable step-up transformer is supplied as an accessory.

Your choice of microphone will therefore fall between moving coil (dynamic), ribbon or capacitor (condenser). Moving coil types have the advantages of robustness and relatively low cost (£8 upwards). Ribbon microphones are famous for their excellent frequency and transient response. They nearly always have a figure-of-eight polar response—but more about that in a moment. However, the incredibly thin ribbon is only lightly tensioned and will produce a “blasting” noise if moved, used outdoors or for close speaking or singing.

Capacitor microphones are complicated by the need for a DC polarising voltage and built-in “head” amplifier. (The source impedance is so high that even a few inches of cable would drastically attenuate the signal.) Until recently this meant that capacitor microphones were too high priced for the home studio. But some less expensive models have appeared, retaining the excellent sound quality of their full professional cousins.

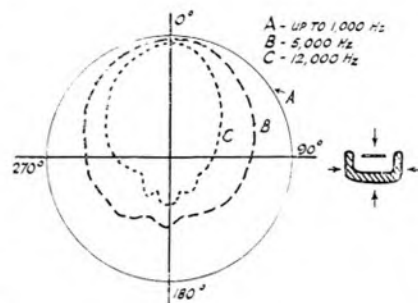

Fig. 1. Omni-directional polar diagram produced by pressure-sensitive microphone. At higher frequencies the response becomes narrower due to reflections from the microphone case

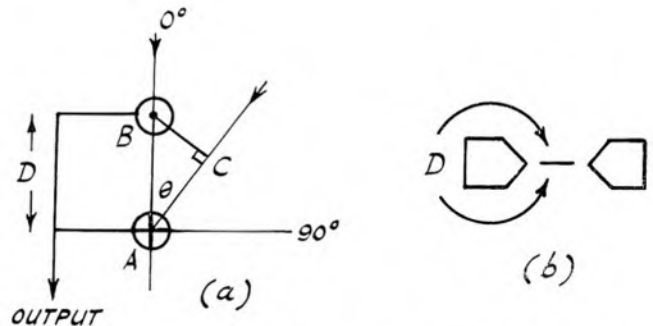

Fig. 2. A pressure-gradient microphone can be thought of as comprising, (a) two pressure-sensitive elements A and B or (b) a single diaphragm open to the air on both sides. Response is maximum at 0° , falls in the ratio AC:AB at θ° and becomes zero at 90°

Omni-directional microphones

Air pressure is essentially a non-directional quantity. Any pressure-sensitive device, such as the human eardrum, an aneroid barometer or a microphone diaphragm will therefore tend to have the same response to sound at all angles. This is illustrated by the polar response diagram, curve A of Fig. 1. The microphone output level for a given sound intensity is shown by the distance measured outwards from the centre.

This non-directional or “omni-directional” response is produced by any microphone whose diaphragm is open to air on one side only. Notice, however, that the circular pattern ceases to apply at higher frequencies. As soon as the microphone dimensions begin to compare with the sound wavelength (from about 4,000 Hz upwards for a 2-inch microphone) the obstacle effect produces a progressively more one-sided pattern (see curves B and C in Fig. 1).

Except for this loss of treble on oblique sounds, the ordinary pressure operated microphone is useful for general purpose recording of speech, music or sound effects. The omni-directional pick-up is an embarrassment in many situations, however, where ventilator or other noises are present or it is necessary to adjust the volume balance between different speakers or musical instruments. In these cases, a directional microphone is preferred; and a brief explanation of how these work will now be given.

Bi-directional microphones

A microphone can be made to sample the sound pressure at two points in space, either by comprising two spaced pressure-sensitive elements A and B (see Fig. 2a) or having a diaphragm which is open to the air on both sides (Fig. 2b). The resultant microphone response is then a function of the change in pressure, or "pressure gradient" due to the spacing D and will be at maximum for sounds arriving on the microphone axis and zero for sounds arriving at the sides. (Compare the effect on a spirit level of rotating it through 360° while it rests on a gradient.)

The polar curve obtained is a figure-of-eight (Fig. 3) and is particularly useful for split balances of musical performers and actors—who can move into the "dead" area for receding or changing perspective. Compared with a circle, a figure-of-eight pattern (really two touching spheres, if we think in three dimensions) has the further advantage that it picks up only one-third of the ambient, reverberant sound. It is therefore better in lively acoustics or, in dead acoustics, may be used at a greater distance for a given balance of direct to reflected sounds.

Cardioid microphones

Useful as it is, the figure-of-eight has relatively narrow angle of pick-up; the response is -6dB at 60° off axis. A better pattern for many purposes would be the heart-shaped, "cardioid" curve shown in Fig. 4, which is only 2.5dB down at 60° and "dead" to sounds over a wide angle at the rear.

A cardioid pattern can be obtained by combining pressure and pressure gradient elements but the most usual method is to employ two pressure sensitive elements as previously with the addition of an acoustical delay network (see Fig. 5). When the delay due to D₂ is equal to that of the physical spacing D₁, the full response is obtained at 0°. This falls to half at 90° and to zero at 180° (see Fig. 4).

The wide frontal pick-up angle is useful for choirs, vocal groups, etc., and of course in Public Address work where the loudspeakers can be placed in the "dead" area to minimise acoustic feedback.

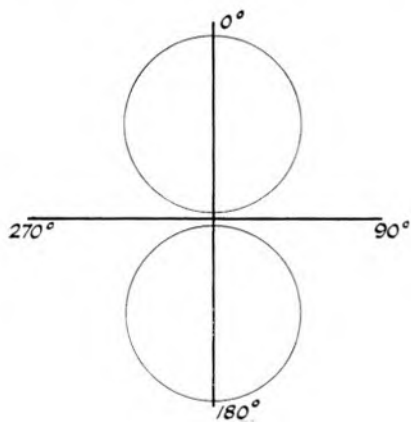

Fig. 3. Figure-of-eight response of pressure-gradient microphone elements shown in Fig. 2

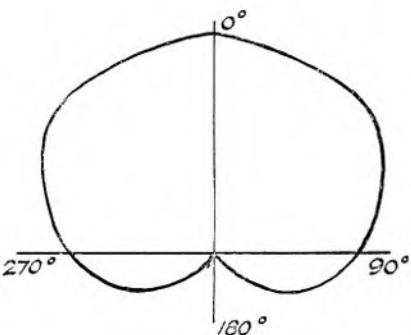

Fig. 4. Cardioid response of gradient plus delay elements shown in Fig. 5

Representative group of four microphones



Reslo Ribbon type RBTS price £15 5s.



Sennheiser type MD409 dynamic cardioid price £29 17s.



Reslo type EC-1 dynamic cardioid price £18



A.K.G. type D200 price £23

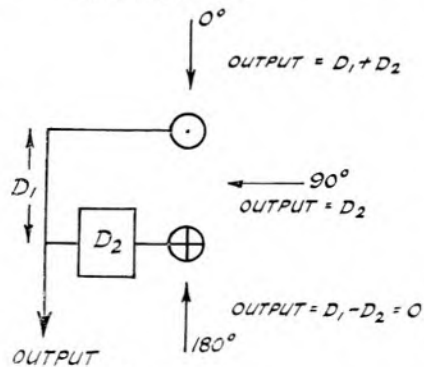

Fig. 5. Acoustic network D₂ introduces same delay as physical spacing D₁, producing cardioid polar diagram

To Sum Up

If only one microphone has to be chosen for the home studio, it should probably be a moving coil omni-directional or cardioid—the latter being perhaps the more versatile. The second microphone, added when funds become available, might be a bi-directional ribbon to increase versatility.

Take care to keep to the same impedance and, if possible, sensitivity rating. Make sure that the connectors are the same type too, for ease of interchanging microphones. A table stand is quite useful but I much prefer a floor/boom stand, even an improvised one. This allows the microphone to be slung at various heights and angles and avoids the inevitable bumps when a table stand is used. Slinging the microphone from a system of ropes or pulleys, attached to strategically placed wall-hooks, is even better since it avoids noises transmitted along the floor.

The more ambitious home studio will need one or more specialised microphones for stereo, noise suppression or remote pick-up (for bird-song recording, etc.). But the first aim must be good recording of speech and music in the home studio itself with a consistent standard of sound quality which can be repeated any time at short notice.

Next month I shall talk about the requirements for non-microphone recording or dubbing from disc, radio and tape.

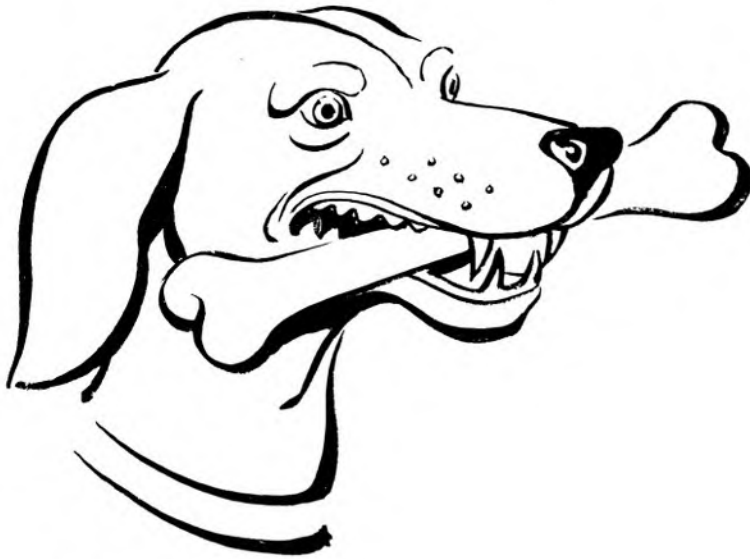

GIVE A DOG A BONE!

By Basil Dawson

POSITION, we are told, is everything. After something like eight years' amateur recording experience I have come to the conclusion that even if correct microphone positions do not absolutely guarantee first-class results they at least give one a sporting chance of getting the kind of quality one wishes for. Like most amateurs I have had to confine my activities to working with strictly non-professional choirs, orchestras and instrumentalists. The "studio" is almost invariably a church, church hall or school hall where problems of excessive resonance demand special care in selecting microphone positions.

Most public buildings of this kind have very similar architectural features which leave the recordist with the problem of access to high beams, capitols of pillars, arches and even vaulting. The individual who has supreme control over what may or may not be done within the building is the caretaker or head verger; usually they are extremely co-operative people provided they are approached tactfully well in advance of the event. But suitable points of suspension for microphones can be difficult, not to mention dangerous, places to reach. Most places are accessible even in a large cathedral provided one is prepared to negotiate dirty, narrow, twisting stairs and gangways—assuming, that is, an iron nerve and a head for dizzy, unprotected, heights. Sometimes a help-

ful verger will offer a ladder; it would be impolite to reject such kindness even if the mere sight of the unwieldy length of twisted and warped timber fills one with apprehensive dread.

But there is another solution. For the princely sum of 1s. 6d. I recently purchased an invaluable accessory which effectively removes much of the danger to life and limb when faced with such a situation. This gadget is an imitation bone—yes, an ordinary soft rubber, dog's bone. With the help of this sophisticated piece of apparatus, a ball of twine and a little careful thought I have been able to place microphones in positions that would otherwise have been quite impossible.

The shape of the bone lends itself to the secure tying of the twine, thanks to the enlargements at each end (the imitation knuckle joints!) which prevent the twine slipping off. The bone is of just sufficient weight so that when thrown it will carry the twine over high beams and brackets which are way up out of reach, and yet it is sufficiently soft not to damage anything it might hit. This latter point is of the greatest importance in churches and cathedrals where the fabric may well be of great age and value.

Having got the twine over some suitable suspension point the microphone cable is attached to it and then hauled up to an accessible height for attaching the microphone head itself. A second length of twine must be tied to the cable at the microphone end before hauling it on up to its final height as modern lightweight microphones may not be heavy enough to come down of their own accord when dismantling. It also proves useful to have more than one such piece attached to the microphone end—by pulling these sideways and attaching them to suitable points on screens or pillars at the sides the microphone can be secured in almost any desired position.

The bone has another use. When it is needed to secure a lashing around a pillar the girth of which is greater than the combined length of one's arms one is faced with quite a problem. At ground level it's quite easy to walk around it, but at a height off the floor the only solution is to use the bone again. After attaching the twine it is thrown outwards and across the back of the pillar. The thin line wraps itself around the stonework and the bone returns to you from the other side. This is a situation that can often be encountered in a church gallery or cathedral triforium and it had always defeated me until I found this simple solution. Perhaps this inexpensive idea might prove of use to others who tackle similar types of work. And when not in use as a recording accessory the bone can of course be serving a most useful purpose by keeping the dog quiet!

Leda Tape

FULLY GUARANTEED ☆ STRONGLY BOXED

Size Base	Standard		Long		Double		Triple	
		P.V.C.			POLYESTER			
3"	150'	2/3	225'	3/-	300'	4/3	600'	8/9
4"	300'	3/9	450'	5/-	600'	8/3	900'	12/6
5"	600'	8/3	900'	9/9	1200'	15/3	1800'	22/6
5½"	900'	10/-	1200'	12/3	1800'	19/3	2400'	28/6
7"	1200'	12/3	1800'	17/3	2400'	21/9	3600'	38/6

Factory Fresh. Superb Quality. Leaders, Trailers and Stop Foils on all sizes 5" and above. We supply many local authorities and professional recording studios. May we supply you? P. & P. 2/6 per order. S.A.E. Full Lists.

LEDA TAPES (T), 30 BAKER ST., LONDON, W.1

Bang & Olufsen – for those who consider design and quality before price.



Bang & Olufsen present the Beocord 1100 – a fully transistorised, 2 track mono tape recorder with advanced technical specifications to semi-professional standards.

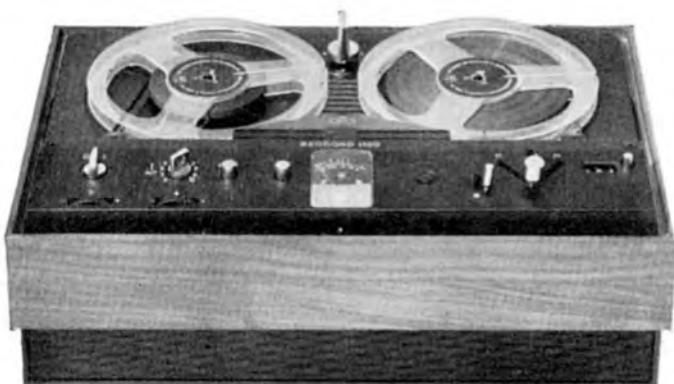

This 1/2 track mono tape recorder incorporates many of the advanced features of the famous Beocord 2000 de luxe series, plus automatic/manual recording, built-in 10 watt RMS amplifier and integral monitor loudspeaker. All spool sizes up to 7" may be used.

The amplifier with its associated independent bass and treble controls facilitates the use of the Beocord 1100 as the heart of a Hi-Fi system.

Designed with minimum overall dimensions, the Beocord 1100 may be accommodated on a bookcase. A fold away carrying handle, plexiglass dust cover and full 7" spool of tape are provided.

Available with Teak or Rosewood plinth.

TECHNICAL DATA

Tape Speeds

1½ in. 3½ in.
7½ in. per. second.

Fast Forward and Fast Rewind

Approx. 150 seconds in both directions for LP tape (1800 ft.)

Controls, Mechanical

On/off switch and speed selector.
Tape control lever.
Tape counter reset button.
Pause control lever.

Automatic Stop

At end of tape or if tape breaks; actuated by metal foil during normal forward operation.

Inputs

Microphone 50-200 Ω.
Gramophone 2.2MΩ/75mV and
Radio 47KΩ/1.6mV.

Outputs

Radio output, 4.7KΩ/0.6V max.
Loudspeaker output 10 watts/4 Ω.

Power Output

10 watts. (built-in loudspeaker max. 3 watt).

Loudspeaker Impedance

4 Ω.

Heads

Combined record and playback head, 30 mHy.
Gap 3 microns. Erase head; Ferrite, 2 mHy.
Gap, 2 × 100 microns.

Erase and Bias Frequency

60 kc/s.

Frequency Response

1½ in/sec.: 30- 8000 Hz (± 2 dB 40- 6000 Hz).
3½ in/sec.: 30-16000 Hz (± 2 dB 40-12000 Hz).
7½ in/sec.: 30-20000 Hz (± 2 dB 40-16000 Hz).

Wow and Flutter

7½ ips - 2%, 3½ ips - 6%, 1½ ips - 6%, all values peak to peak.

Weight

28.6 lb.

Dimensions

W = 17½ in.
D = 11½ in.
H = 7½ in. with dust cover.

BANG & OLUFSEN, United Kingdom Division, Eastbrook Road, Gloucester. Telephone: OGL2 21591.
London Showrooms: 70/71 Welbeck Street, London, W.1. Telephone: 01-486 2144.



Official U.S. Navy photograph

The desolate wastes of Antarctica showing a typical base camp with a supply ship surrounded by ice

HIGH ADVENTURE

A REPORT ON THE ADVENTUROUS LIFE BY DENIS GILBERT

DID you imagine that tape recording is a sedentary occupation only to be undertaken in the comfort of the home from the interior sprung ease of a deep armchair? It may be for some, but for others it involves high adventure with thrills galore.

Banner headlines in the national press recently proudly proclaimed a British victory. The story was of the unqualified success of one of the most competitive climbs since the conquest of Mount Everest by Sir John Hunt's team in 1953. Racing against an Italian team sponsored by the Italian Alpine Club, a joint British expedition of mountaineers from Yorkshire and Glencoe had fought their way up the 9,000-foot mountain of Cordillera del Paine to tackle the virgin peak of "The Fortress"—a 4,000-foot granite monolith towering on top of it.

The British expedition was made up of five climbers from Yorkshire and four from Glencoe under the joint leadership of Ian Clough from Scotland and Ian Howell from Yorkshire. With them they took a Fi-Cord 202 portable battery tape recorder loaded with Scotch 290 triple-play tape. The plan was to record every

detail of their day-to-day experiences so that the tapes could be used as a diary from which a book is to be written on their return. Recorded material is also to provide a commentary to the official film of the expedition and the slide shows which will illustrate their remarkable adventures when they return to this country.

It does not require very much imagination to appreciate that weight must be reduced to an absolute minimum on such a trip. Priority must go to the essential equipment upon which the team's very lives will depend. It was for this reason that four-inch reels of micro-thin triple-play tape were used. Each spool provided the expedition with 9½ hours of dual-track recording time with a weight penalty of only 2½ ounces. The polyester backing makes it ideally suited for use in the extremes of temperature experienced in Patagonia.

The ascent itself presented the climbers with conditions which combine the difficulties of the Alps with the remoteness of the Himalayas. Tremendous gales can sweep off the Patagonian icecap to give a climate unparalleled outside the Polar regions.

Overall leadership of the expedition is in the hands of Ian Clough who is a professional mountain guide and one of the most experienced climbers in the country. His wife, Niki, a trained nurse with three Alpine seasons' experience, is acting as medical officer to the expedition. All the other climbers are veteran mountaineers of the highest grade.

We all know now that success has crowned their efforts. Not only did they conquer the peak but they won the race with the Italians. All that remains is for us to offer our sincerest congratulations and to await the thrilling details of the story when they return.

In describing the terrible weather conditions that our climbers had to endure we referred to them as being "unparalleled outside the Polar regions." And yet we have news of another expedition that will penetrate deep into the Antarctic. At the invitation of Sir Vivien Fuchs, the editor of the International Zoo Year Book, Mr. J. Lucas, is undertaking a tour of British Antarctic bases in Graham's Land. As a zoologist Mr. Lucas will be making a special study of seals, particularly leopard seals. His exciting stories will be published in a number of our

leading newspapers and periodicals; we are indeed fortunate at *Tape Recording Magazine* to have been able to secure exclusive rights in the audio press. As his adventurous story unfolds it will be published in these pages.

No explorer would dream of setting out without a camera—under modern conditions the tape recorder is equally essential. Sound coverage of this trip has been requested by the BBC and so a great deal of thought had to be devoted to the operational difficulties of recording in temperatures of as low as minus 50°.

With the co-operation of the Rank Organisation, the distributors of Akai tape recorders, Pullin Photographic, carried out a special investigation into one of their X-4 portable battery machines. First of all the Service Department changed the oil for a lubricant of lower viscosity and then the machine was packed into a deep freeze unit for 24 hours. Only in this way could the cruel Arctic temperatures under which it would have to operate be reached.

Mr. Lucas himself was present when the machine was removed from deep freeze and to everyone's delight it worked perfectly. So with the Akai X-4 and a supply of Scotch Dynarange tape in his luggage Joseph Lucas is at this moment on his way to the desolate Antarctic wastes. We shall be reporting both on his progress and on his recording experiences during coming months.

So the spirit of adventure is not dead. The enterprising individuals concerned in our stories of the climb up "The



The forbidding peak of the 4,000-foot monolith scaled by the British team of mountaineers. The seemingly impossible sheer vertical sides of smooth granite earned it the name of "The Fortress"

Fortress" and the expedition into Graham Land are specialists. They have the advantages of both years of experience and (presumably) financial backing.

The man-in-the-street is in a very different position. Many have a yearning to undertake memorable exploits but all too often such dreams evaporate into nothing with the passing of the years.

But there is much that can be done

without undertaking enterprises of extreme hazard. Even the Antarctic itself has this year been opened up to tourists. A party of nature-loving enthusiasts, including Mr. and Mrs. Peter Scott amongst their number, have recently left London on a four-week voyage that will take them nearly as far as Joseph Lucas proposes to travel. Most of them are ordinary tourists—people like you and I. Their one qualification is the ability to pay the charge of something more than £1,000.

Even in this country the call of adventure and outdoor life need not go unanswered. At The Camping and Outdoor Life Exhibition at Olympia there was displayed a vast range of tents, camping trailers and motorised caravans. In this field the most expensive equipment is frequently found to be the least suited to really adventurous life. Continental frame tents are today like canvas palaces and can cost more than £100. With picture-frame windows and separate internal rooms, they offer a standard of luxury and comfort hitherto undreamed of. By contrast, the mountaineers' and walkers' tents have changed little in design over the years. Made from special lightweight canvases, the very best can still be bought for around £20 or even less.

With a rucksack, a lightweight tent and stout walking boots, the most beautiful country in the world is open to us to explore. And to do that job properly we must be sure to include the equipment that the professionals find essential, a portable tape recorder.

JAN FEB MAR APR
MAY JUN JULY
AUG SEPT OCT
NOV DEC

DID YOU KNOW—

- That **TAPE RECORDING MAGAZINE** was the First Publication of its kind in Europe.
- That it is still the **Best Tape Recording Magazine.**

- That it is the only **Tape Recording Magazine** staffed by **Enthusiasts for Enthusiasts.**
- That you can ensure receiving your regular monthly copy by handing your newsagent the coupon below.
- **THAT TAPE RECORDING MAGAZINE IS STILL ONLY 2/- MONTHLY.**

TO MY NEWSAGENT

I would like to be sure of receiving **TAPE Recording Magazine** regularly.

Please order it for me.

NAME.....

ADDRESS.....

Tape Recording Magazine is distributed by Trans-World Circulation Co.

THE FINE ART OF MULTI-TRACK

By an anonymous contributor

IN last month's article I introduced drum rhythm records which are ideal for the multi-track enthusiast and can be used without copyright problems for private purposes only. These records contain a variety of rhythms in various tempi and have "count-in" signals so that one can commence playing exactly on the first beat.

Most of the tracks are two times 32 bars, suitable for two complete choruses of most of the popular tunes. This precludes the use of a four-bar introduction and extended endings, but by recording the rhythms on to tape an extra number of bars can be "spliced in" quite easily. For example, we require 70 bars to provide a 4 bar introduction, two 32 bar choruses and an extension ending of 2 bars—total 70 bars.

First copy a 2 x 32 rhythm on to tape twice. This provides a total of 128 bars which means that altogether 58 bars must be cut out and the remaining tape spliced exactly at the correct point between one bar and the next. It can be done easily as follows. Run the tape through on the first recording and count off the number of extra bars required. In this case we count off 6 bars after the count-in and cut the tape exactly midway between the 6th and 7th bars. The rest of the recording is run off until the first actual beat of the sound recording is reached. Cut the tape midway between the last count-in pip and the first beat. Now splice the extra 6 bars on and you have a recording consisting of a count-in, a 4 bar introduction, 2 x 32 bars plus a 2 bar extension ending.

It sounds complicated and difficult but with a little practice tracks of any number of bars can be made up this way. One does not have to waste the tape containing unwanted bars in the way I've just described; it is really only necessary to copy the extra bars from the record, always working from the beginning so as to include the count-in signal. Splicing exactly midway between bars is not difficult once you get the feel of counting and stopping the tape at exactly the right moment.

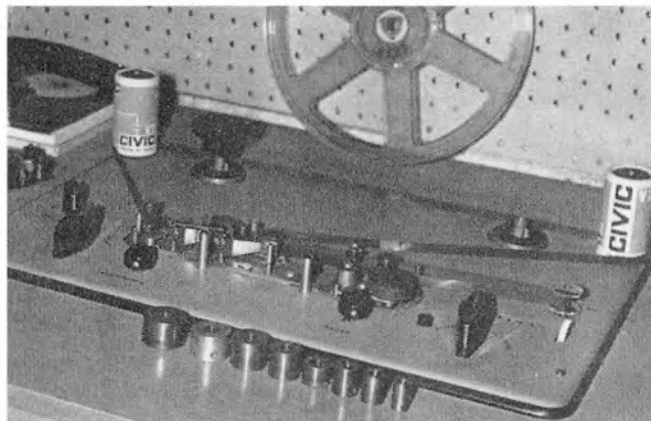

Fig. 1. A typical "tape loop" arrangement on a Brenell deck. Note various sizes of capacitors in the foreground; these allow a wide choice of non-standard tape speeds

Tape Loop Rhythm

For the production of unusual rhythms the tape loop technique offers endless possibilities and again we can apply the technique of cutting and splicing a recording to provide exactly the right number of bars. Loop rhythms are used quite a lot in electronic music productions, but they do have the disadvantage of becoming monotonous and of sounding mechanical. However, the general idea is to record various percussive sounds and cut these from the tape. The pieces are then cut to lengths equal to the time values required for the rhythm and are joined together to form a loop. (Fig. 1) This loop is then copied continuously for the total number of bars required. Don't forget to leave an extra one or two bars for counting in.

There is no reason why extra percussive sounds shouldn't be added in time with the loop rhythm whilst this is being copied. This technique does enable one to produce a little variation here and there. Managing the loop does, however, require a good deal of initial experiment with regard to suitable sounds and rhythmic patterns. A very good example of a loop rhythm can be heard in a recording made by the BBC Radiophonics Workshop. It is called *Time Beat* and is available on Decca record, number 45-R4901.

Simulated Percussion

There are a number of "electronic" rhythm machines available, and these are greatly favoured by organists and pianists who have to play solo in restaurants and similar places. Realistic simulated sounds of various instruments including snare drums, traps and bongo drums can be produced with a wide range of rhythms from a very slow to a very fast tempo.

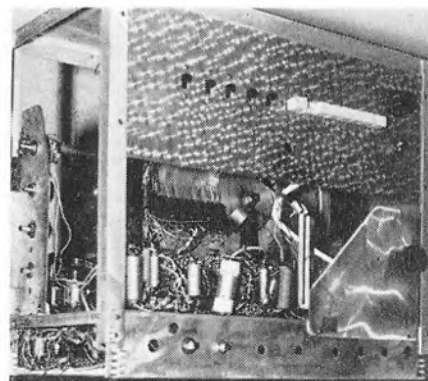

Fig. 2. A home-constructed electronic rhythm unit which provides various popular rhythms with simulated drums of various kinds and cymbals

The tempo is continuously variable. But such units are rather costly at £120 to £150. The writer recently designed and constructed a machine for the simulation of such percussion sounds in various

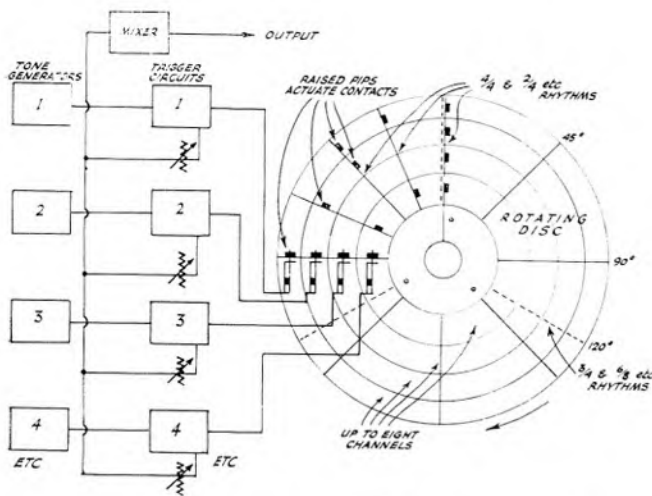

Fig. 3. Schematic diagram of electronic rhythm unit described in the text

rhythms and with variable tempo. Such a device, as shown in Fig. 2, is not beyond the capabilities of those with a good knowledge of electronics and mechanics plus the necessary workshop equipment and electronic test gear such as an oscilloscope and audio generator.

The basic principle of the home-made rhythm machine is shown in Fig. 3 and consists of a number of "sound" generators which are triggered off by contacts actuated by small raised blocks on a rotating disc. The disc is driven from a synchronous motor in such a way that variable but otherwise constant speed is obtained. This is done by driving on the flat surface of the disc between predetermined inner and outer points, as shown in Fig. 4.

The contacts used for triggering off the sound generators are standard gold-plated electronics organ note contacts. The sound generators consist of the following:—

1. White noise generator for drum brush and cymbal sounds.
2. 40 Hz pure tone generator for bass drum sounds.
3. Click generator for trap sounds.
4. Triggered circuits with inductive tuning for bongo drums at different pitches.

The requisite attack and decay characteristics of the different sounds are produced electronically by means of triggering amplifiers. Each circuit output is fed via a preset volume control to a common mixing circuit, the output voltage from this being large enough to feed a tape recorder or external amplifier and speaker.

The contacts for the different sound generators can be switched so that the sounds used in standard rhythms such as the Tango, Common time, Rhumba, Samba and Waltz, etc. can be varied. A "crash" cymbal effect can also be switched to sound on the last beat of every one bar, every fourth bar or every

eighth bar. Rhythm combinations can also be inter-switched.

Summing up on rhythms I think it is safe to say that there is no shortage of possibilities for the lone recordist/musician who may not have a drum kit. Percussion rhythm may not always be necessary; it all depends on the kind of music one intends producing, but for popular tunes, old and new, a percussion rhythm does lend background and is a wonderful aid to playing in time and at constant tempo. Later in this series of articles I will include some of the basic circuits used in the rhythm machine and

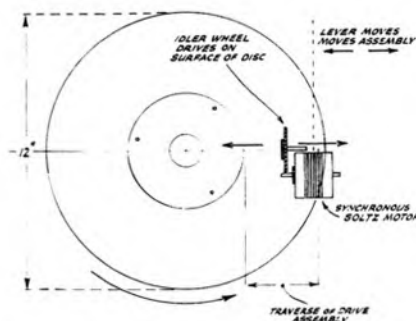

Fig. 4. The method of surface drive on a flat disc used to obtain constantly variable speed

also circuits for useful small accessories to multi-tracking and electronic music.

Recording with Electric Guitar

Time after time I receive letters from guitarists who have been unsuccessful in producing multi-track recordings of good quality despite their abilities as musicians. Many of the letters are about poor recording quality, high noise levels and hum. Most of these faults can be traced to poor matching between the guitar electro-magnetic pick-up and the tape recorder (or mixer), poor screening on connecting

leads and wrong matching between tape recorders and auxiliary equipment.

Most guitar electro-magnetic pick-ups are high impedance and will usually provide enough output to load the "radio" or "gram" inputs on the tape recorder or a "high level" signal input on a mixer. If the output from the guitar pick-up is not high enough to produce full recording level when connected in this way then a high impedance microphone input should be used.

It is no use turning the recording volume control up as high as it will go in order to get sufficient signal from the guitar. This will only bring up the hum and noise of the tape recorder or mixer amplifiers. Always aim for an approximate "half-way" setting on volume controls for full recording level. This will help keep amplifier hum and noise at a minimum.

Some guitar pick-ups are low or medium low (around 1,000 ohms) impedance and may not match properly into a normal high impedance input. Because of this signal transfer is poor and the volume controls have to be at or near maximum to achieve full recording level. The only solution here is a matching transformer or a pre-amplifier with an input impedance comparable with the guitar pick-up impedance.

Next comes the problem of coupling between one tape recorder and another. (This will not normally apply to track-to-track recorders which are designed with accurate matching between circuits). When connecting one tape recorder to another it is essential that a high impedance, high signal level output is used; that is the socket usually provided for connecting to an external hi-fi amplifier. Equally, it is essential that this signal is taken to a high impedance, high level input on the second machine such as "radio" or "gram" inputs. Do not couple the extension loudspeaker output of one tape recorder to any input on a second machine. This will only transfer all the hum and noise at the output stage of the first machine. Much the same comments apply to the use of signal mixers where accurate matching and maximum signal transference is important. On the subject of mixers—except in certain cases, which I will deal with later—passive or resistive mixers without amplifiers should not be used. They attenuate signals too much; recovery of the lost gain by bringing up recording or playback volume controls only introduces unwanted hum and noise.

Next month I will cover the use of simple hum filters and perhaps continue with a little more about the musical side of multi-tracking, half speed record/replay techniques and the direct connection of electronic organs to a tape recorder.

TEST BENCH

AKAI 3000-D



INVESTIGATED BY R. HIRST AND D. KILLICK

MANUFACTURER'S SPECIFICATION AKAI 3000-D

Tape Speed: 3½ and 7½ ips.
Wow and Flutter: Less than 0.15 per cent RMS at 7½ ips. Less than 0.25 per cent RMS at 3½ ips.

Frequency Response: 30 to 22,000 Hz. ± 3 dB at 7½ ips. 30 to 14,000 Hz. ± 3 dB at 3½ ips.

Distortion: Within 2 per cent 1,000 Hz 0 VU.

Signal/Noise: Better than 50 dB.

Input Level: Mic. more than 0.5 mV. Line more than 50 mV.

Output Level: 0 VU 1.23 V RMS.

Equalisation: To the NAB Curve.

Recording Level Indicator: VU meter x 2.

Recording System: 4-track stereo/mono.

Fast Forward and Rewind Time: 150 seconds using 1,200 feet tape on 50 Hz mains. 120 seconds using 1,200 feet tape on 60 Hz mains.

Heads: One each Record, Playback and Erase.

Motor: Induction type.

Transistors: Silicon transistors x 17, Diodes x 2, Rectifiers x 2.

Power Supply: AC 100 to 240 V, 50/60 Hz.

Power Consumption: 30 VA.

Dimensions: 11¾ inches high x 15¼ inches wide x 5½ inches deep.

Weight: 25.3 lbs.

Price: £86 (excluding accessories).

Distributors: Pullin Photographic Ltd., The Rank Organisation, 11, Aintree Road, Perivale, Greenford, Middlesex.

AKAI 3000-D TEST CHART

Frequency Hz	Overall Response dB		Playback Only dB	Signal/Noise Ratio dB	Cross-talk dB	Distortion
	7½ ips	3½ ips	7½ ips			
30.....	-5.0	-6.0	-4.5			
40.....	-1.0	-2.5	-1.5			
50.....	+0.5	-0.5	0			
60.....	+0.5	+0.5	0			
100.....	+1.0	+1.0	+0.5			
250.....	+1.0	+1.5	+0.5			
500.....	+1.0	+0.5	+0.5			
1000.....	0	0	0	51	46	1.6%
2000.....	-0.5	-1.0	0			
4000.....	-1.0	-1.0	-1.0			
6000.....	-2.0	-1.5	-1.5			
8000.....	-2.0	-2.0	-2.0			
10000.....	-2.0	-2.0	-2.0			
12000.....	0	-1.5	-2.0			
14000.....	+1.5	-2.5	-1.5			
16000.....	+2.0		-1.0			
18000.....	+2.0		0			
20000.....	0		-0.5			
22000.....	-2.0		-2.5			
Wow and Flutter	0.12%	0.22%				

NOTES.—The Overall Response figures relate to record and playback. Playback Only relates to the reproduction of a 50 microsecond test tape at 7½ ips (N.A.B.).

For Signal-to-Noise Ratio the tape was recorded at peak level and then the input signal was removed from the record amplifier. By reference to the signal level recorded and the resultant tape noise, the noise voltage was read off, with the tape still in motion. Distortion is quoted against a 1,000 Hz signal recorded at the correct maximum level as indicated by the manufacturers, and the figure is an R.M.S. value.

Wow and Flutter is also R.M.S., the test frequency being 3,000 Hz. Test equipment used includes: Bruel and Kjaer Signal Generator, B & K Frequency Analyser Type 2107, B & K Level Recorder Type 2305, Marconi Distortion Factor Analyser and Gaumont-Kaylee Wow and Flutter Meter.

IN examining this machine we are considering its technical standard, range of facilities and concept of design in relation to retail price. The equipment is of considerable interest because it appears to represent the culmination of an endeavour on the part of its Japanese manufacturers to produce a tape recorder approaching professional specification and yet maintaining a cost level that the amateur enthusiast is likely to be able to afford. The 3000-D, as evolved by its designers, is therefore a high quality 4-track stereo record/playback mechanism that has been relentlessly shorn of every ancillary feature that does not directly relate to good quality sound reproduction.

It has neither loudspeakers nor audio output stages and so requires to be used in conjunction with an existing amplifier and speaker installation.

Efore considering what the machine will and will not do we will take a look at the results of our laboratory investigations which are displayed in the usual tabular form. It will first be noted that the specification claims a frequency response of from 30 to 22,000 Hz ± 3 dB at 7½ ips and 30 to 14,000 Hz ± 3 dB at 3½ ips. This we could not substantiate because as our tables show there was a considerable fall-off at 30 Hz. However, if the manufacturer had made his claim as from 40 to 22,000 Hz (at 7½ ips) then

as our figures show he would have been amply justified. In fact had he further restricted his claim to 40 Hz to 20,000 Hz he could have reduced his tolerance to ± 2 dB for the reproduction of an NAB calibration tape—the record/playback curve at 7½ ips even extends to 22,000 Hz within that tolerance.

We will refer to the fall-off at the extreme bottom end of the audio frequency spectrum later in this review. In the opinion of your reviewers it is of very little significance. Far more important are the signal to noise ratio and distortion content readings. We find that the former is 51 dB below peak level with a distortion content of fractionally less than 1.6 per cent. This is a truly remarkable state of affairs for ¼-track operation. This measurement was taken at 7½ ips and

held good over the frequency range of 40 to 20,000 Hz. Cross-talk, measured at 1,000 Hz, was found to be 46 dB between tracks below a signal recorded to peak level; in subsequent listener tests the advantages of this excellent separation were quite apparent. We were rather afraid that the manufacturers might have sacrificed good engineering principles for the sake of reasonable retail cost and so we were relieved to find that the Wow and Flutter figure at 7½ ips was as low as 0.12 per cent RMS and even at 3¼ ips was only 0.22 per cent RMS.

To summarise the technical findings we can say that the Akai 3000-D was found to be well within its manufacturer's specification in every respect other than the frequency response at 30 Hz, which in every case was outside specification by 2 or 3 dB. With this in mind we examined the operator's manual very closely.

We found it to be one of the best and most clearly written we have come across with any Japanese machine. In particular we should like to compliment Akai on the devotion of a full page to the subject of "head cleaning." This page carries the statement in bold type right across its width: **"Tape oxide deposits are 90 per cent of the causes of your tape recording failures."**

How very, very true. To emphasise their point the manufacturers include photographs of clean and dirty heads together with pen charts of frequency response curves resulting from a clean head and a dusty head. The latter naturally shows a steep and shaky nose-dive from 1,000 Hz to 6,000 Hz—after which, nothing. But further examination of these frequency response curves give a clue to our loss of response at 30 Hz. The "clean head" curve is clearly reproduced showing minus 18 dB at that frequency. This leads us to believe that the figures quoted in the official specification may well be a misprint and should read from 40 Hz to 22,000 Hz, etc., etc.

A further comment must be made about the instruction book. At the back it lists the standard accessories that are supplied with this machine. These include a microphone with stand, an interconnecting lead fitted the DIN plug and four separate RCA (phono) plugs, spare fuse, rubber caps, silicon oil, felt pads, vinyl leather lid and manual. The only items received with the review machine were the two rubber caps for the spool spindles and the operator's manual. Inquiry of the distributors confirmed that our equipment was precisely as offered in this country. The explanation accounting for the missing items is that the instruction book is a general English language version issued in all countries where English is spoken. The policy in Great Britain is to omit accessories that might not be required in order to maintain the highly competitive retail price.

Styling of the 3000-D is absolute simplicity. A straight-sided teak veneered box contains the deck mechanism. There are no handles and no hinges. As can be seen from the illustration 7-inch tape spools slightly overhang the enclosure. Everything is as compact and as severe as it can be. In a recessed panel on the left-hand side we have four phono sockets for Line-in, Line-out, Right-hand and Left-hand channels. In addition there is a standard DIN 5-pin socket enabling users owning an amplifier with this type of connection to use a single cord to give full record/playback facilities.

The deck itself is dominated by the black plastic cover to the sound channel and enormous rubber pinchwheel and totally exposed capstan. The easiest way to explain this deck is to follow the tape path in its

travel from magazine to take-up spool. Leaving the magazine spool it first passes a tape guide. We particularly noted that this is not the usual fixed pillar but is a freely rotating guide which will therefore offer the minimum of resistance. Next the tape passes the tape cleaner. This fitting contains a cylindrical felt pad which the user lightly moistens with special tape cleaning fluid. The purpose of this rather unusual fitting is to both remove loose oxide before it reaches the heads and also to offer some degree of lubrication so as to prevent tape squeak. From here the tape passes across the three heads, one each erase, record and playback. Please note that the tape does not drop into a slot—the magnetic heads stand exposed under the slight overhang of the plastic head cover. There are no pressure pads nor any other impedimenta at the rear of the tape. Not only does this arrangement eliminate possible sources of excessive head wear but it also has the advantage of leaving the heads permanently exposed for cleaning and offers immediate access for editing. The tape then proceeds between the capstan and the pinchwheel to a tape tensioning arm which also serves as both an automatic stop and coupled mains on/off switch. From this point the tape is laced on to the take-up spool in the normal manner.

Continuing our description of the main deck plate we have in the centre what might at first be taken to be a speed-change switch but which is actually a rotating control used—in conjunction with a slide switch on the underside of the machine—to change from 50 to 60 Hz mains operation and vice versa. Since this will never need to be used unless the machine is operated from a mains supply of a frequency other than that which is standard in the country in which it is sold it seemed to us to be a rather unnecessary complication. The purpose would have been better served with a concealed pre-set control.

To the front left of the main deck plate is a two-position rocker switch for selecting the correct equalisation (which is to NAB standard) for 7½ ips or 3¼ ips. A three-position control is mounted on the upper face of the head cover and this selects either stereo or 4-track mono.

The recommended track sequence for mono operation is 1-4-3-2. The track selector knob is turned firstly to the position marked "1-4 Left" for recording on track 1 first and then on track 4 after the tape spools have been turned over. Next the selector knob is turned to the position "3-2 Right" and the sequence is repeated. Four track mono recording is confusing at the best of times and it is felt that strict adherence to the recommended procedure could easily make that confusion more confounded.

We now come to a most interesting feature of this machine. Changes of speed between 7½ ips and 3¼ ips are effected manually by changing sleeves on the capstan. A sleeve storage post is provided on the deck and for 7½ ips operation the knurled retaining screw is undone, the sleeve removed, slipped over the 3¼ ips capstan and then held firmly in place with the same retaining screw. Such an arrangement may appear to be somewhat primitive to those who are used to changing speeds with the flick of a switch; it does, however, have two great advantages. Firstly it reduces cost by dispensing with unnecessary mechanical complications and secondly it eliminates speed instability caused by idlers or other speed changing mechanism. There is no mechanical or electrical linkage between the equalisation switch and the

capstan so one has to be very careful to remember to set that control correctly.

Tape movement is controlled by two substantial function levers. The first has two positions, Play and Record, the latter being interlocked with a record safety button on the deck plate. The other function lever merely gives the fast-wind positions, Rewind to the left, Forward to the right. The feature that impressed us least on this machine is the rather crude and awkward brief pause control lever. This we found to be extremely clumsy and difficult to use. It can be locked into position but there is a knack in persuading it to engage and then releasing it is equally difficult. The instruction manual states that the brief pause must be used to hold the tape stationary whilst setting recording levels, but we found this to be unnecessary. Other fittings on the main deck plate are a pair of jack sockets for microphone input and a three-digit rev. counter and reset button—the figures on this counter are legible but extremely small.

Mounted along the front of the deck is the row of main controls set off against a black escutcheon plate. On the far right is the mains on/off switch. This is most unusual because it is linked to the tape tension arm. If the machine is connected to the mains with the switch in its Off position power will still be applied to the equipment as soon as tape is laced up. Used in this condition mains power will be automatically shut off again when the end of the tape is reached. So the user can, if he wishes, operate this machine with the mains switch permanently in the Off position. When turned to On it over-rides the secondary mains switch to the tensioning arm and enables the machine to switch on in the conventional manner. One interesting result of this arrangement is that it is impossible to switch off the main power supply whilst tape is laced up. It is the first time we have come across this system in an amateur equipment.

Next we find a red record warning light which is illuminated when the machine is in its record function and opposite to that a jack socket for stereo headphones. A pair of VU meters, one for each channel, are also situated on this panel with their respective rotary gain controls on either side. The meters are a little small but as they are permanently illuminated when current is applied the needles are reasonably visible. Gain control knobs are smaller than we prefer and once again Akai have omitted to provide them with any form of reference scale. Perhaps if we remind the manufacturers of this irritating little omission frequently enough they might eventually take the hint!

On the extreme left is yet another two-position rocker switch which selects the monitoring functions—Play-back on one side and Record the other. We must mention that the machine may be used either horizontally or vertically and when placed in the latter position it stands on a pair of rubber skids to protect the table and requires rubber retaining caps to hold the tape spools in place.

As soon as we had wired up the equipment to a Wharfedale System 20 amplifier it was noted that the pair of meters operated when the monitor function switch was set to the Record position. Hence our suggestion that it is unnecessary to use the brief pause control to assist in setting levels. For initial tests, however, we reproduced one or two pre-recorded tapes of known quality standards. Outlet from the 3000-D is at a fixed level, which at 1.23 volts RMS is certainly high enough for most amplifiers—in fact it

Please turn to page 126

TEST BENCH

Continued from page 125

might even overload the tape inputs of some. It is naturally necessary to throw the monitor switch to Playback position and we were pleased to note that the meters operate on playback to give a visual indication of the signal being fed out. The sound quality we were getting from a pair of full range speakers was absolutely excellent. With good stereo separation, minimal background noise and smooth frequency response we can say without doubt that we have never heard those tapes reproduced better. Our only criticism of the 3000-D as a playback machine is the fact that there is some slight increase in background noise when the tape is stationary. This noise is far below what we might call the "annoyance level" and it will not be heard when the tape is in motion, which, after all is what counts. We mention this simply for the sake of strict accuracy.

Trial recordings were taken from VHF radio and no difficulty at all was experienced in setting correct levels. Operation of the monitor switch permits an immediate comparison between the signal being fed into the machine and the recording coming off the tape. Even at 3½ ips we could detect no audible difference between the before and after record signals, and in fact we had to stop the spools turning to be quite sure that the after record signal really was the playback of the tape. As a record/playback instrument the 3000-D was behaving in a really exemplary manner.

We must mention one or two criticisms however. The most important concerns that old bugbear of pinchwheel and capstan

separation. If the automatic stop is allowed to operate in either the playback or record modes then the capstan and pinchwheel will remain under pressure. Because this automatic shut-off is linked to the mains on/off there is a strong possibility that the equipment will be allowed to shut itself down completely at the end of a tape run with the inevitable result of damage to the rubber pinchwheel unless the operator remembers to turn the run lever back to its neutral position. There is no warning about this in the instruction book, and we regard this as a grave omission. Will owners and prospective owners please note the absolute necessity for returning the record/playback control to its neutral position when the tape is not in motion. Neglect of this will cause the pressure of the capstan on the rubber tyre of the pinchwheel to produce surface irregularities that must lead to heavy wow whenever the machine is used. It would be a sin to spoil the performance of this piece of equipment through carelessness, so please make sure it doesn't happen.

One of your reviewers found the run levers somewhat clumsy and awkward to use; he actually managed to jamb one of his fingers between the rear of the lever and record safety lock button. It is debatable whether this should be regarded as a criticism of the machine or the reviewer! To be serious, we mention this small point to indicate that tape transports whose functions are controlled by rotating levers are generally somewhat more clumsy to operate than decks using piano key type controls. Lastly the rewind time, which at just under four minutes for twelve hundred feet of tape (specification says 150 seconds) requires a little patience.

We have discussed this machine in rather critical detail. This has been done deliberately because we wanted to try to convey whereabouts economies have been made so far as we could judge. It is impossible to make and sell a near perfect machine for the price at which the 3000-D is being offered. The manufacturers seem to have aimed at producing the finest possible sound quality at the expense of mechanical convenience. Even so attention to necessary detail is scrupulous as is obvious by the provision of a rotating tape guide and also by the way that the heads were found to be highly burnished.

This machine could not claim to be a Rolls Royce amongst tape recorders; it can, however, claim to achieve a standard of technical performance far in excess of that indicated by its cost. It will appeal to the man who wants top quality without frills, who can appreciate good sound when he hears it and who wants his tape recorder to look like a smart piece of furniture rather than an ugly suitcase.

Those who can pay several times the price will get a machine of sweeter mechanical operation but we strongly doubt if they will get better recordings. We have no doubt that the Akai 3000-D will solve the "What to buy" question for many people. As for us, we have become so attached to it that we are acquiring it as our second playback machine for the evaluation of pre-recorded tapes.

MUSICASSETTE

REVIEWS

TCHAIKOVSKY. Violin Concerto in D Major, Opus 35. Henryk Szeryng violin with the London Symphony Orchestra conducted by Antal Dorati. Philips CPC 0021, 40s.

When the reviewer is biased he should always admit it. I must therefore at once confess that the Tchaikovsky Violin Concerto has long been one of my favourite works. The composer was more at home with the piano than the violin; it has even been said that his composition in the Violin Concerto was more suited to the pianoforte. And yet who could really resist the sublime melodies and rhythms of this famous concerto?

With a good stereo spread the overall recorded quality is excellent. Szeryng's violin is given just the right degree of prominence. As usual Antal Dorati wields his baton with the unflagging zeal of a dedicated perfectionist. Those who have not worked closely with a virtuoso violist can have no idea of the sound that the instrument is capable of producing—both in quality and in quantity! Having been privileged to work with some of the finest instrumentalists in the country I have no hesitation in saying that although something is lost in this recording—as might be expected at 1½ ips—what is left is both wholly acceptable and satisfying.

A Musicassette to delight the millions who, like me, regard this as one of their favourite pieces of music.

MENDELSSOHN Symphony No. 5 in D Minor "Reformation." Symphony No. 4 in A Major "Italian." New Philharmonia Orchestra conducted by Wolfgang Sawalisch. Philips CPC 0020, 40s.

When this Musicassette was placed in the playback mechanism I was immediately disturbed by the relatively high level of background noise. A few of these recordings have some rather peculiar scraping or banging noises recorded on the first so-called "silent" few seconds of tape, and these can be extremely irritating when they form a prologue to the opening bars of music. When this opening blacksmith's chorus is then followed by persistent background noise obtruding into the programme one really must object. Unhappily such is the case with my copy of the Mendelssohn 5th. Recorded quality was otherwise so good, so very good that judicious top cut considerably improved matters without losing brilliance.

Of the two works in the album the 4th, or Italian, Symphony on side two is undoubtedly the better known. Inspired by a visit to Italy in 1930 the composer described the work himself as his "merriest" composition. Bubbling over with more energy and zest for living than could even be claimed for a patent breakfast cereal, the Italian Symphony is a superb exposition of the life, the art and the antiquity of that great country.

By contrast the Reformation is a simple statement of faith in the Protestant religion. As such it has infinitely greater depth than the Italian. The composer's perfect craftsmanship and ear for melody enabled him to create five symphonies that have long been regarded as amongst the finest ever written, and these are two of them.

Having noted the presence of the background noise I listened carefully to see how

far my enjoyment suffered. To my surprise I found that I had ceased to notice it before I was half-way through the first movement; from thence on all was pleasure.

WE SHALL OVERCOME. Pete Seeger. CBS 40-62209, 40s.

This album was recorded live at the artist's Carnegie Hall Concert on 8th June, 1963. The enthusiasm and excitement of the audience readily conveys itself to the listener as the programme builds up.

The cult of the protest song is one of the more healthy phenomena to come out of the United States. Heaven only knows there's enough to protest about. Many, many voices are raised in that great land to register personal abhorrence of war, racial discrimination and other social evils. The validity of the protests are beyond dispute—one can only question the sincerity of the individual protestor.

In this album a brilliantly transparent recorded quality would reveal the slightest hint of insincerity. But insincerity was the one quality I found lacking. The programme comprises: *If you miss me at the back of the bus, Guantanamera, I ain't scared of your jail, Oh Freedom, That's what I learned in school, Who killed Norma Jean? Who killed Davy Moore? A hard rain's a-gonna fall, Mail myself to you, Keep your eyes on the prize, Little boxes, Tshotsholosa (Road Song) and We shall overcome.*

Of these I cannot help expressing a preference for *Little Boxes*. This is surely the protest song to end all protest songs. If modern life and living did not relentlessly mould separate individuals into stereotyped, unthinking automatons then the other evils would not exist at all. Or at least one would like to think that that would be the case.

An album to set you thinking; as such it deserves pride of place in your collection.

NEW



SERIES

NATURE NOTES

FOR MARCH

BY RICHARD MARGOSCHIS

BY the end of March the presence of a delicate green haze on the hedgerows and trees will herald the arrival of Spring. Once these new leaves are fully developed it will be much more difficult to spot birds for visual identification, in fact quite often it is easier to get a bird's song on to tape than to see the bird itself. Birds that have wintered here will be on their way out, or at least preparing to leave, and the situation will not yet be complicated by the large influx of summer visitors which is going to occur next month, so this is a good time to become familiar with our residents. It is worth while concentrating visually and aurally on the songs of some of these birds so as to be able to identify them the moment you hear their song; it will considerably simplify matters in a few weeks' time when many more species are singing. Our resident birds will now be pairing and getting on with the job of nest building, in fact many will already be sitting, and during these weeks it is common to see courtship displays going on, often accompanied by unusual vocal utterances: so song is not the only thing to listen for.

It can be very useful to note where nests are being built or are actually in use, for a period of watching will reveal several song posts used by the cock while the hen incubates. When these posts are found a reflector can be set up at a convenient distance, or alternatively an open microphone can be placed very near to the song post. In either case a lead is run to a convenient spot where the operator can sit with the recorder, a situation where low impedance microphones are a big help, if not essential. When you do carry out any work of this nature do be sure that you in no way disturb the bird. It should not be necessary to put a microphone close to the nest because the song will not be coming from there, but a microphone near to a song post will cause very little embarrassment, in fact the bird will probably take no notice of it at all. The situation is rather different when the young have hatched, it would then be reasonable to put a microphone near, but only for short periods in order not to disturb the feeding cycle.

I have previously pointed out the importance of not disturbing birds when they are nesting. A new Act, the Protection of Birds Act, 1967, came into force on the 14th January, and it contains many points of particular interest to ornithologists, such as restrictions on the use of nets, ringing, etc. Of direct interest to those seeking only to record birdsong is the fact that the Act makes it an offence for any person to wilfully disturb any wild bird while it is on or near a nest containing eggs or unfledged young, if that bird is included in Schedule 1 of the Act.

Space prevents printing the names of the 48 species included in the Schedule; in any case I think it is unnecessary, because if it is an offence against the Act to disturb a Wryneck whilst at its nest, it is just as much an offence against the unwritten laws of the naturalist to disturb a sparrow under similar circumstances.

The Thrush is probably one of our best known birds and his song is certainly one of the strongest. With a sound level meter I have measured notes from a thrush twenty yards away ranging from 70 to 75 decibels; when you think that traffic in a street averages 80/85 dB you get a good idea of the power of the thrush's voice. The Song Thrush has a better voice than its cousin the Mistle Thrush and is identified by the repeated and more varied phrases. The Mistle Thrush, greyer in appearance and with bigger spots on his breast, is the larger of the two birds and generally delivers his song from the top of a tree.



TELEFUNKEN

The Powerful Partnership

Stereo amplifier: solid state for a big solid sound. And a stereo tuner that really separates one channel from the other

V 201 stereo amplifier A level of performance that far exceeds the modest price. 2 x 25 watts continuous output power; 26 transistors; wide frequency range, extremely low harmonic distortion. Wide range of accessory sockets. Painstakingly designed for the stereo enthusiast who demands the very best technical specification. Hear the V201 at good specialist dealers... a truly superb sound. Recommended retail price: £108.12.0.

T 201 stereo tuner A perfect partner to the V 201. A fully-transistorised, all-waveband tuner with particularly powerful FM sensitivity. Automatic tuner (AFC), FM stereo indicator and separate AM/FM tuning. Excellent separation of signals from stereo channels: cross-talk attenuation better than 26 dB at frequencies below 6,300 c/s, better than 20 dB below 10,000 c/s. Very high selectivity: watch the signal strength meter drop all the way to zero in between stations. Recommended retail price: £89.9.5. Both units are matched in teak and light matt walnut cabinets.

Write today for fascinating FREE colour booklet to AEG (Great Britain) Limited 27 Chancery Lane London WC2.

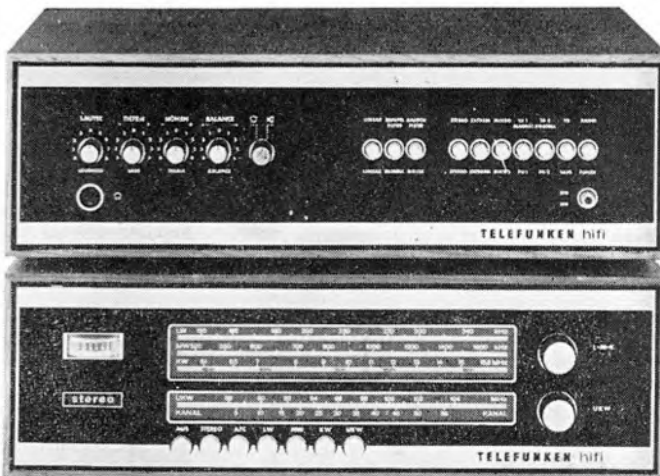

DEVELOPMENTS in electronics follow each other at such a rate that the ordinary man-in-the-street can be excused for retreating into a state of bewildered confusion. But in tape recorders we have virtually reached the stage where improvements in electronic performance will be of no benefit to the user because of the limitations imposed by the magnetic tape itself. The next break-through in development must come from the tape manufacturers.

Now there is news of a completely new recording tape developed in America by DuPont. It is claimed to reproduce test tones up to 20,000 Hertz at a tape speed of $1\frac{1}{2}$ ips. The new tape, called Cronyl, uses chromium dioxide instead of the usual iron oxide for its magnetic coating. A wide frequency range at slow tape speeds is impossible with iron oxide tape because the tiny metallic particles refuse to conform to the extremely tight waveform needed at high frequencies. However good our electronics might be we shall never record 20,000 Hertz at $1\frac{1}{2}$ ips on existing tape. But according to its manufacturers, with Cronyl we can.

Before there is a rush to the shops to stock up with this new wonder tape let me hasten to explain that it is not yet available commercially, even in its country of origin, America. And there are snags, too. It will probably cost up to half as much again as existing good quality, low noise, tapes. Because of this cost factor, and also the need for relatively high bias settings, it is even suggested that Cronyl will never be generally available on the domestic market.

Whether or not we shall ever be able to purchase this material in retail shops is, in my opinion, irrelevant. What is significant is the practical feasibility of producing wide range recordings at low speeds. To me this means just one thing—the mechanical engineering boys will really have to pull their socks up, because if we are to achieve good overall quality at slow tape speeds we must have speed stability. There will be a crying need for a tape transport system operating at $1\frac{1}{2}$ ips but having a total wow and flutter content of around 0.15 per cent RMS, or less.

We have had the electronic break-through, and obviously tape development is not lagging far behind. Strange that the mechanical requirements look like being the last to be up-dated. Whatever changes will take place within the next five years—and there will be plenty—one thing will remain unaltered. Professionals will continue to record at 15 ips because of the difficulty of editing to very fine limits at slower speeds; and creatively minded amateurs will do the same for precisely the same reason.

CROSS

TALK

By Audios

THE owner of domestic recording equipment can hardly be expected to feel vital concern for the welfare and prosperity of either the firm who made it or the shop who sold it to him. It is easy to forget that the products of efficient and prosperous organizations are likely to offer the consumer better value for money than equipments made in basement "factories." A strong, go-ahead, audio industry is in everyone's interests.

Predictions for the future are very bright. The 3M Company has forecast an "explosion" in tape recorder sales in the U.S. by estimating that one quarter of American homes will have at least one tape recorder in use within the next couple of years. This is good news indeed. There is no reason to suppose that the same pattern will not be followed in this country. In spite of economic gloom there is a strong possibility that prosperity for the tape recorder industry may be just around the corner. Let us hope that one result of this expanding market will be even better value for money for the consumer.

* * *

A TAPE recorded interview with that grand old man of music, Igor Stravinsky, was reported at length in a recent edition of the "Weekend Telegraph Colour Magazine." This remarkable eighty-five-year-old has keener wit and sharper perception than most at half his age. His comments on the difficulty of distinguishing today between music and non-music are particularly interesting and amusing.

Stravinsky underlines the absurdity of calling art Art only when it appears in a gallery and calling music Music when it is heard in the concert hall. There was no direct reference to contemporary musique concrète, but I can imagine what the maestro's reaction would be to treating the sound of flushing lavatory cisterns and howling cats as musical components. As for the human howling that accompanies so much guitar strumming. . . !

But then Stravinsky is old enough and wise enough not to set himself up as an absolute arbiter. There is always the chance that today's peculiar sounds may be tomorrow's "real" music—and we who play around with sound on tape are handling it physically in a manner that was never possible for any other generation. If only we had the mind of Stravinsky.

But the genius of the brilliant few shines brightest against the dull mediocrity of the rest of us. So if we can't be great at least we can contribute something by being dull—which, after all, is better than being absolutely nothing!

* * *

AT the weekend my house was in a state of complete and utter chaos. The decorating bug had bitten us. All the furniture from the largest room in the flat was distributed over the remaining floor space—in the living room, in the bedroom, in the hall, wherever it could be jammed. Having coped successfully with the ceiling and most of the paintwork I found myself on Sunday fighting a losing battle with wallpaper. It bulged, it bubbled, it stained. Nothing would go right. At the very height of the crisis the telephone rang. Apologetically I was told that a mistake had been made in notifying me of the date for an important organ recording.

"Sorry old man, I'm afraid it's tomorrow. You will be there with all the gear, won't you?"

Would I be there? The telephone handset was stuck, apparently permanently, to my hand. All the recording equipment was buried vaguely behind mountains of furniture. Why do things like this always happen to me?

* * *

BEFORE we can look around Easter will be with us, and to me Easter means amongst other things that annual jamboree of ear-splitting sound and technical mumbo-jumbo familiarly known as the Audio Festival and Fair. If your head has never ached nor your mind boggled as you walked the corridors of the Russell Hotel, then Sir, you are not, like me, an incurable audio fair addict.

Once again the Russell Hotel will absorb thousands upon thousands of enthusiasts into its endless demonstration rooms; once again our feet will wearily plod the carpeted corridors. And at the end we shall pronounce it "the best ever"—just as we did last year, and the year before, and the year before, and the year before. . . .

Nothing would prevent me from attending. Every year I see something new and learn something new. The long suffering manufacturer endures my dafter questions and patiently tries to get me to comprehend the incomprehensible. Walking from room to room is like visiting one's oldest and dearest friends. In spite of its critics we should be thankful that such a major event is held annually in this country. I've visited a good many trade and industrial exhibitions in my time, but none of them have anything like the friendly and personal atmosphere of the London Audio Fair. So book the date now. April 18 to 21 at the Russell Hotel as usual.

* * *

A CUSTOMER walked into one of the larger hi-fi shops, pointed out a row of tape recorders on an upper shelf and asked the bored looking assistant if they could be demonstrated.

With a half stifled yawn the assistant grudgingly offered to do as he was asked, provided the customer first made up his mind which one he was going to buy. . . .

UHER

the ONLY tape recorder for YOU...

4000 REPORT SERIES Three different models of the Uher 'Report' are now available:

4000 Report - L

As illustrated. Specification: 2 Tracks conforming to international standards-2; Tape reels diam.-5"; Tape speeds (ips) $\frac{1}{2}$, 1, 3, 7 $\frac{1}{2}$; Frequency range (cps) 40-4, 500/40-10,000 and 40-16,000/40-20,000; Dynamic volume range (db) 40 at $\frac{1}{2}$ ips, 46 at 1 ips, 50 at 3 ips, 52 at 7 $\frac{1}{2}$ ips; Wow and flutter (max \pm %) 0.2% at 7 $\frac{1}{2}$ ips; Recording mono; half-track; playback mono half-track; Power output one watt.

Monitoring via headphones or speaker; VU meter + three digit tape counter; tape stop-start remote control, collectorless motor controlled by 8 transistors; power supply from 6V, 12V, 24V car battery, from rechargeable accumulator or 5 flashlight cells 1.5 Volt; 17 transistors.

Microphone, radio, pick up input: 1V at 15 Kohms and 2V at 4ohms. Weight 6 lbs (approx). 121 gns.

4200 Report Stereo

Affording all the advantages of the successful 4000 Report-L in size, style and specifications—plus stereo. 146 gns.



4400 Report Stereo

Again with all the advantages of the 4000 Report-L—plus stereo and maximum economy of tape on four tracks without deterioration of reproduction quality. 146 gns.



724 L Stereo

Specification: 4 Tracks conforming to international standards-4; Tape reels diam.-7" Tape speeds (ips) 3, 7 $\frac{1}{2}$; Frequency range (cps) 40-14,000, 40-18,000; Dynamic volume range (db) 45 at 3 ips, 46 at 7 $\frac{1}{2}$ ips; Wow and flutter (max \pm %) 3 ips 0.2, 7 $\frac{1}{2}$ ips 0.15. Recording mono and stereo; Playback mono and stereo; Power output. 2 x 2 watts; Microphone, radio, pick up inputs, output 1V at 15 Kohms and 2.8V at 4ohms. Weight, 20 lbs (approx.) 97 gns.

DISTRIBUTED IN U.K. BY

BOSCH

The range of UHER tape recorders and accessories available in the U.K. satisfy the requirements of every amateur and professional enthusiast.

...when quality is your first concern

... always ask for UHER tape recorders and accessories. Quality is the simple, single aim behind their manufacture. Their production is also the sole pre-occupation of the UHER Company, whose specialisation has led to many outstanding developments, including the first application of printed-circuit techniques in tape recorder manufacture. For further details contact BOSCH LIMITED, UHER Division, Rhodes Way, Radlett Road, Watford, Herts. Telephone Watford 44233.

BOSCH

has established a universal reputation for quality backed by continuous research, development and over 80 years of manufacturing experience. 85,000 BOSCH employees are universally engaged in the research, manufacture, distribution and service of BOSCH products. These include an impressive range of domestic appliances; radios; stereograms; tape recording equipment; automotive accessories and safety equipment; electric tools; hydraulics; language laboratory and closed circuit television systems... all of which are marketed in the U.K. by BOSCH LIMITED... a member of the BOSCH GROUP.

tapes

Lulu
Love Loves To Love Lulu
Columbia TA-SX6201

The Dave Clark Five
Everybody Knows
The Dave Clark Five
Columbia TA-SX6207

Procol Harum
Regal Zonophone TA-LRZ1001

The Box Tops
The Letter—Neon
Rainbow
Stateside TA-SL10218

The Shadows
From Hank, Bruce,
Brian & John
Columbia TA-SX6199

**The George Mitchell
Minstrels**
Show Time Special
H.M.V. TA-CLP3642



musicassettes

The Seekers
Seekers Seen in Green
Columbia TC-SCX6193

The Shadows
From Hank, Bruce,
Brian & John
Columbia TC-SCX6199

Frankie Vaughan
There Must Be A Way
Columbia TC-SCX6200

Wout Steenhuis
Wout Steenhuis Meets
The Kontikis
Columbia TC-SCX6191

MUSIC ON TAPE

3 $\frac{3}{4}$ ips. MONO

ODE TO BILLIE JOE. Bobbie Gentry. Capitol TA-T 2830, 35s.

When Bobbie Gentry, the girl from the Deep South, first came out with *Billie Joe*, the Press hailed her as some kind of genius. "Her lyric is sheer poetry," they said. At the time, although I found *Billie Joe* a rather haunting number, I couldn't agree. The words didn't really make complete sense to me . . . and they still don't. If punctuating the sad story of a young boy's suicide with references to black-eyed peas and general supertime conversation constitutes genius, then I'm a Dutchman. But genius apart, the record was an undoubted success. Now, we have this tape—and hang it, practically every other number sounds *exactly* like *Billy Joe*! I'm not joking—speed, formula, delivery and backing . . . all the same.

All this apart, Bobbie Gentry has an unusual and listenable voice, and the production of this tape is extremely nice. There's sometimes the feeling that she's there in the room with you (her and *Billie Joe*) and judging by her picture on the liner, that wouldn't be such a bad thing!

To sum up, the tape's okay—but it would have been a lot better if Miss Gentry had forgotten about being a genius and had gone in search of something more varied in the way of material.

The tracks: *Mississippi Delta; An Angel Died; Chickasaw County Child; Sunday Best; Nickie Hoeky; Popp's Won't Let Me Go To Town; Bugs; Hurray, Tuesday Child; Lazy Willie; Ode to Billie Joe.*

SHOW TIME SPECIAL The Black and White Minstrels. HMV TA-CLP 3642, 35s.

Either you like the Minstrels, or you hate 'em. Personally, they turn my stomach. But I've got to admit that this tape is a varied and extremely listenable arrangement of a massive, non-stop selection from all sorts of shows. We move from *Rose Marie*, through *Guys and Dolls*, *My Fair Lady* and *Bless The Bride*, to *Wild Violets*, *White Horse Inn* and *The Mikado*.

I bless the producers of this medley for keeping that fearful Jolson imitator's contributions to the minimum, but others might disagree. Space hardly permits a complete listing of the numbers performed. The total is an incredible forty-four! Suffice to say that everything is clear and crisp to the ear, and constantly changing in mood, tempo and presentation. Whatever one thinks of the Black and Whites, they couldn't be accused of a dull performance.

SEEKERS SEEN IN GREEN. The Seekers. Columbia TA-SX 6193, 35s.

Columbia seem to have taken more trouble with the sleeve notes here than with the actual tape. We are informed that the main performers play Maton guitars and bass instruments, and we have a complete listing of all the musicians in the accompanying orchestra.

Big deal. I've nothing against the Seekers whatever, but this tape is frankly awful. Maybe this was one of their off-days, but the singing is actually putrid in patches. What's more the recording—at least on my copy—is patchily putrid as well.

Tracks of note—or should I say notoriety—are *59th Street Bridge Song* (a dull, drearily performed rendering when compared to the bouncy original by Harper's Bizarre) and *The Sad Cloud* . . . which really is sad.

Is it too unkind to say that this tape deserves a spin . . . into the nearest waste-bin?

Love Is Kind, Love Is Wine; The Sad Cloud; 59th Street Bridge Song; If You Go Away; All I Can Remember; Chase A Rainbow; Angeline Is Always Friday; On The Other Side; Cloudy; Can't Make Up My Mind; Rattler; Colours Of My Life.

FROM HANK, BRUCE, BRIAN AND JOHN. The Shadows. Columbia TA-SX 6199, 35s.

No doubt about it, the Shadows are an imaginative and professional group, both in writing and performing numbers. For all that, I wouldn't say that this tape comes across as particularly exciting. It's very adequately recorded, and the individual instruments come across clearly—specially Hank Marvin's tasteful lead guitar, which he plays impeccably as usual. Five of the fourteen tracks are Shadows originals—one of them being a rendition of Cliff Richard's recent hit "The Day I Met Marie". Personally, I think the Shadows ham this up too much. In fact all the tracks and vocals are pretty poor. There are a couple of tracks that seem to be composed by Japanese, but neither has any oriental flavour.

The tape might possibly grow on one after fairly constant listening, but it certainly lacks initial impact.

Titles: *Snap, Crackle and How's Your Dad; Evening Glow; A Thing Of Beauty; Naughty Nippon Nights; The Wild Roses; San Francisco; The Letter; The Tokaido Line; Holy Cow; Alentejo; Last Train to Clarksville; Let Me Take You There; The Day I Met Marie; A Better Man Than I.*

GYPSY FIRE. Ron Goodwin and his Orchestra. Columbia TA-SX 6187, 35s.

It's such a terrible temptation to grab at the title of this tape and say that a Gypsy fire would indeed be the best place for it.

That would be totally unfair, for Ron Goodwin is a masterly director, and the selection of music is excellently and dramatically played. However, I can't really imagine the sort of person who would buy this purely for the pleasure of listening. If there were any startling effects to astonish and arouse admiration within the souls of tape-recording enthusiasts, that would be another matter . . . but if there are any such high spots within the tracks, then I couldn't find them. The recording itself seems to me to be something of a curate's egg. Good in parts. One or two tracks are crisp and clear cut, with a nice balance between the instruments of the orchestra. Others are confused enough to sound as though they'd been recorded in a large, empty hall.

The selection consists of *The Gypsy Fiddler, Black Eyes, The Ritual Fire Dance, Andaluza, Hora Staccato, Gypsy Moon, Czardas, La Paloma, Bublitschki, Play Gypsy, Two Guitars, and Hejre Kati.* (I wonder what that means?)

Surely the object of issuing popular tape recordings is to sell them. I really can't see this one as a commercial proposition, and to my mind, even the most dedicated of caravan-dwellers—even the estimable Bublitschki himself—wouldn't care to trade a *Hejre Kati* for it.

YOUR LOCAL DEALER

LONDON

Lee Electronics

THE TAPE RECORDER & HI-FI AUDIO SPECIALISTS

400 EDGWARE RD., LONDON, W.2 (PAD 5521)

London's leading Stockists of High-Fidelity and Audio Equipment. Many bargains in new and reconditioned equipment.

SEND FOR FREE LISTS OF RECORDING TAPES, RECORDERS, AMPLIFIERS, ETC.

APPOINTED B. & O. AGENTS

- ★ TAPE RECORDER HIRE
- ★ TAPE TO DISC 78 & LP
- ★ RECORDING STUDIO
- ★ TAPE RECORDER REPAIRS
- ★ SALES—EXCHANGES

MAGNEGRAPH

1, Hanway Place, London, W.1.
Tel.: LANgham 2156

THEATRE ORGAN DISCS and TAPES

ORGAN OF THE MONTH CLUB brings out a new Theatre Pipe Organ record each month. Our discs are playable on Mono or Stereo equipment. Approx. 38 minutes playing time 31/6d.

7 $\frac{1}{2}$ ips. 4 track stereo tapes 41/7d.

Full details from:

CONCERT RECORDING
P.O. BOX 2,
ROTHWELL, KETTERING, NORTHANTS

Any MUSICASSETTE BY RETURN POST

Our catalogue lists every available Musicassette in detail. Send for your FREE copy now (enclose 6d. stamp for postage)

LIBRARY AND PART EXCHANGE SERVICE AVAILABLE

For double quick mail order service send to:

GRAMO-TAPES LTD.
Newport Crescent, Middlesbrough.

YOUR LOCAL DEALER

LONDON

Masseys Centre of Sound

West London's Hi-Fi tape Recorder Specialist
—Demonstration Room with Comparator
APPOINTED FERROGRAPH DEALER

AT CHISWICK, W.4

Accessories, All Kinds—Servicing—Pre-Recorded
Tapes Mono/Stereo
121-123 High Road—10 a.m.—7 p.m.

◀ TEL: CHI 2082 ▶

(not closed for lunch)

TAPE RECORDER HI-FI CENTRE (SHEEN) LTD.

—The Centre for—

FRIENDLY HELP—SALES—SERVICE
DEMONSTRATIONS ANY TIME—ALL PRE-
RECORDED TAPES—STEREO—MONO
LANGUAGES—DANCE—JAZZ—SHOWS
CLASSICS, etc.—2 and 4 TRACK—STOCKISTS
OF ALL MAKES AND MODELS OF RECORDERS
AND HI-FI—Add sound to your movies with
Synchrodek—WE ARE STOCKISTS OF
SYNCHRODEK

TERMS—EXCHANGES, ETC.

3/4 STATION PARADE, SHEEN LANE,
SHEEN, LONDON, S.W.14
(Opposite Mortlake Station, S.R.)

Showroom: PROspect 0985

9 a.m.—6 p.m. Closed Wednesdays.

THE SOUTH

THE SOUTH WEST

TOM MOLLAND LTD.

Invite you to visit their
well-equipped

Demonstration Theatre and
compare all the leading makes of
Hi-Fi and Tape Equipment at

110 CORNWALL ST., PLYMOUTH
Telephone 69285

Immediate delivery to ALL Areas

MUSICASSETTES

Send 6d. in stamps for comprehensive catalogue,
part-exchange details and library service.

All makes of cassette machines are supplied at cut-cash
prices.

Blank cassettes, Carrying cases, Language Courses, etc.

ALL MUSICASSETTES REVIEWED
IN THIS MAGAZINE ARE AVAIL-
ABLE FROM US BY RETURN POST

THE MUSICASSETTE SUPPLY COMPANY
13, Angel Street, Worcester.

For Jiffy-fast Postal Service

MUSIC ON TAPE

7½ ips STEREO

BEETHOVEN. Symphonies Nos. 7 in A Major, Opus 92, and 1 in C Major, Opus 21. Berlin Philharmonic Orchestra conducted by Herbert von Karajan. Ampex DGA8806 4-track stereo 7½ips. 75s.

This album is yet another of the delightful Ampex/DGG version of all nine Beethoven symphonies performed under the baton of Herbert von Karajan with the Berlin Philharmonic Orchestra. In this remarkable series every symphony so far heard has been of outstanding recorded quality and the performances of the Berlin Philharmonic have left nothing to be desired. The present album gives us the Seventh and First with No. 7 on Side 1. I do feel it is rather a pity that the publishers did not work through the nine symphonies in strict numeric sequence; this would have been of great advantage to music students since textbooks often adhere to this order.

It is usual to find that a composer's first symphony is really a prologue making statements that will be extended and developed in later works. Beethoven's First stands unsupported by any subsequent work as a masterpiece in its own right; but it does nevertheless point the way towards the grandeur of his later compositions.

In the Seventh symphony—as with the Eighth in F—we have a change of emphasis from the pure nobility of the Fifth into a state of tranquil joy. This did not prevent the writing of the slow movement in truly noble terms. Here Karajan excels. Never dragging, never laboured, the Berlin Philharmonic produce some truly glorious sound.

As with the other Beethoven symphonies in this series already reviewed, strongly recommended.

FRANZ LEHAR. The Merry Widow. Elisabeth Schwarzkopf, Hanny Steffek, Nicolai Gedda, Josef Knapp, Eberhard Waechter and the Philharmonia Orchestra conducted by Lovro von Matacic. Angel ZB3630 4-track stereo 7½ ips. 120s.

This album is a complete version of The Merry Widow offering a playing time the equivalent of two single records, hence the price of £6. It is a German language performance, and unaccountably no English translation or even sleeve notes are provided. Is it assumed that The Merry Widow is so well known that listeners will not need guidance? If so the publishers make a great mistake. To the casual listener the melodies will be familiar but to a great many, particularly the younger generation, the story will be completely unknown.

As an old fogey myself I cannot help putting this work at a disadvantage by remembering that it was a favourite entertainment for the unlamented Adolf Hitler. I forget just how many times he went to see it, but it was said to be his favourite way of spending an evening at the theatre. Having put that rather unpleasant thought at the back of my mind I settled down to enjoy the music. And very enjoyable it is too. One must remember that in its day it was as popular as any of our modern musical shows.

We have received many requests to publish details of equipment used by us when listening to stereo tapes for review. The items used this month are therefore listed below. It will be noted that every component is duplicated—each tape is heard on two quite different combinations of playback equipment before comments on quality are published. Amplifiers—Quad valued and Wharfedale transistorised. Loudspeakers—Celestion and Jordan-Watts. Tape Recorders—Akai 3000D and Tandberg 64X.

Both recording and performance are good, but I do think that most people's enjoyment would have been increased if explanatory notes and an English translation had been enclosed. Schwarzkopf is outstanding as one would expect and I was delighted to find the pleasing tenor of Nicolai Gedda included in this album. The Merry Widow is essentially a light-hearted entertainment and this recording offers a delightful version of it. Not a tape that will please everyone, but it will give extremely pleasant listening to operetta enthusiasts.

THE MIGHTIEST WURLITZER with Eddie Weaver at the Mosque Wurlitzer, Richmond, Virginia. Organ of the Month Club CR0019 4-track stereo 7½ ips. 41s. 7d.

It was a Briton, Reginald Foort, who played no small part in establishing the popularity of the rebuilt Mosque Wurlitzer in the 50s. The instrument had suffered a chequered career. Falling into disuse during the great depression between the wars, it was silent for twenty years. Rebuilding costs proved prohibitive and the instrument was only preserved due to the voluntary efforts of local enthusiasts who spent two years rebuilding it in their spare time.

By no means the largest instrument of its kind it has nevertheless distinctive tonal qualities of its own which are undoubtedly influenced by the architecture of the auditorium itself. The imaginative programme provided includes: *Dance of the Hours, Secret Love, Georgy Girl, Stumbling, It's All Right With Me, Somewhere My Love, I Ain't Down Yet, Hungarian Rhapsody, I'll go home with Bonny Jean/Coming through the Rye, Something Stupid, Thoroughly Modern Millie, Impossible Dream, and Sweet Georgia Brown.*

The organist, Eddie Weaver, is claimed to hold all-time records amongst theatre organists. He has played daily to theatre audiences for 43 years. There is nothing either stale or tired about his performance of the items in this album. In fact I suspect he probably had the final word on choosing the selection of items.

Here we have the s-m-o-o-t-h-e-s-t of smooth sounds. The sleeve notes refer to acoustic reflections from the hard plaster-faced walls within the building. How ever it is achieved the result is quite remarkable. An individualistic character of blend and quality that has probably never been excelled. The recording engineer, Bob Carson, must have faced some extremely tricky problems; he has overcome them brilliantly. Another Organ of the Month Club success.

PUCCINI. Madame Butterfly (highlights). Victoria de los Angeles and Jussi Bjoerling with Miriam Pirazzini and Mario Sereni. Orchestra and chorus of the Opera House, Rome, conducted by Gabriele Santini. Angel ZS35821 4-track stereo 7½ ips. 75s.

As in all albums of "highlights" we have here a selection of the most popular items from what must be the most popular of all Puccini operas. Choice of programme is good and the names of the artistes speak for themselves.

Stereo is an excellent medium for operatic records. In a good recording the listener experiences a natural sense of the movement of the characters within the limits of the sound stage. Having set the stereo balance accurately at the beginning of playback one must be careful to leave controls strictly alone; it is only too easy to (apparently) send a singer skating from one side of the room to the other by merely adjusting relative volume levels on the two channels.

In this album we have excellent performance and recording with a convincing stereo spread that enables the listener to enter into the dramatic action. A broadsheet within the box gives a brief synopsis of each situation together with Italian and English translations of the text. The extracts included are: *Dovunque al Mondo, Amore O Grillo, Butterfly's Entrance and Love Duet*. These are all from Act 1. On Side 2 we have *Un bel dì, Flower Duet and Humming Chorus* from Act 2 and *Addio, Fiorito Asil and Butterfly's Death*. Throughout the tape balance is exceptionally good and in particular the chorus is used with great effectiveness. An album that can be recommended to anyone who has not yet included Madame Butterfly in their library of recorded music.

GRACE BUMBRY SINGS VERDI OPERA ARIAS. Orchestra of the German Opera, Berlin, conducted by Hans Löwlein. Ampex DGC8987 4-track stereo 7½ ips. 75s.

Grace Bumbry is an exceptionally colourful figure in every sense of the word. It has recently been said that her voice is estimated to be worth no less than £100,000 and she has also had considerable publicity as a motor-racing driver. Her brilliant red 180 mph Lamborghini is well-known on the international circuits. Does she, I wonder, sing to herself as she drives? I find myself doing this quite unconsciously sometimes in a sort of toneless monotone—if Grace were to really give voice I have no doubt that she could be clearly heard above the roar of her massive engine, but perhaps she could then be disqualified for unfairly distracting other drivers' concentration.

However, here we are concerned with the quality of Grace's voice, rather than her driving ability. At public performances she has received enthusiastic critical acclaim. My own feeling about the Bumbry voice is that although technically beyond reproach it is, to my ear, too perfect. By this I mean that she lacks the warmth and feeling—sense of dramatic situation if you like—that we find with Los Angeles or Callas. So although the voice delights the ear it lacks the passionate depths that are, to me at least, an essential part of operatic performance.

The programme comprises a selection of popular Verdi extracts and includes: *Stride la Vampa* (Azucena's Canzona) from "Il Trovatore," *Condotta Ell'era in Ceppi* (Azucena's Narration) from "Il Trovatore," *Ritorna Vincitor* (Scene and Romance of

Aida) from "Aida," *Tu Che le Vanità* (Scene and Aria of Elizabeth) from "Don Carlos," *Nel dì Della Vittoria/Ambizioso Spirito tu Sei/Vieni t'Affretta* (Scene and Cavatini of Lady Macbeth) from "Macbeth," *La Luce Langue* (Aria of Lady Macbeth) from "Macbeth," and *Una Macchia è qui Tuttora* (Sleepwalking Scene of Lady Macbeth) from "Macbeth."

This lack of emotion was particularly noticeable in the famous Macbeth sleep-walking scene. A comparison with the Callas version of this item immediately revealed the basic Bumbry weakness. Apart from this there is plenty of enjoyment in the album and the pleasure is increased by the provision of the usual two language text. In all respects recording is up to the usual Ampex-DGG high standard. An excellent tape for those more interested in vocal perfection than in dramatic opera.

BRIGHTON BRASSY. Douglas Reeve at the Hill, Norman and Beard Organ, The Dome, Brighton. Organ of the Month Club CR0020 4-track stereo 7½ ips, 41s. 7d.

Devotees of the theatre organ cannot be other than delighted with this brilliant recording. The instrument itself was installed in The Dome at Brighton during the rebuilding of the interior in 1935. Details of its design are quoted in the news sheet accompanying the tape. I was particularly interested to note that the bottom seven notes of the open diapason were originally produced electronically, but owing to imperfections in electronic techniques in the 1930s they did not last very long.

Recorded items are *Pack Up Your Troubles, Espana, The Grenadiers, Thunder and Lightning Polka, Le Rêve Passé, Bird Songs at Eventide, Morning Noon and Night in Vienna, Sousa Medley, El Relicario, Primero, La Paloma, In a Clock Store, The Mikado* and *Pack Up Your Troubles*.

There are a number of problems that will always be encountered in recording either a church organ or a theatre organ in really good stereo. Usually recording sessions are held when the auditorium is empty. The presence of an audience or congregation has a profound effect on the acoustics of such a building. In the present case the seating capacity of The Dome is for over 2,000 persons. When every seat is filled the damping effect will be considerable. Without an audience the acoustic is likely to be exceptionally bright, with sound rolling about all over the place and possibly producing unpleasant peaks. There is just a suggestion of peakiness about this recording although on the whole sound quality is very good. A surprisingly good stereo spread has been obtained under what must have been extremely difficult conditions.

The organist, Douglas Reeve, is a native of Brighton and he has been organist at The Dome Concert Hall for more than twenty years. His style is economic but effective. Resisting the temptation to indulge in musical histrionics, he employs all the facilities of his magnificent instrument with judicious care, producing a melodic sound that does not tire the listener. An extremely pleasant and worthwhile album.

A reminder to readers that Organ of the Month Club tapes (and discs) are issued to members only. Correspondence should be addressed to Concert Recording, PO Box 2, Rothwell, Kettering, Northants, and payment should not be included. As tapes are sent direct from the USA delivery can take up to about five weeks.

YOUR LOCAL DEALER

THE NORTH

CHESHIRE

CHARLESWORTH'S
OF CREWE LTD.

Tape Recorder
and Hi-Fi Specialists

Head Office: 14 Hightown, Crewe. Tel. 3327
Hi-Fi CENTRE: 28 HIGHTOWN, CREWE.
Technical Division: 19 Ludford St., Crewe.

TAPE RECORDER CENTRE (HALIFAX)

stock all the best
Tape Recorders, Hi-Fi Equipment,
Tape, Pre-Recorded Tape, etc.

REVOX
specialist

30 King Cross Street, Halifax
Phone 66832

CUSSINS & LIGHT LTD.

YORK'S LEADING RADIO
TV & ELECTRICAL STORE

Visit our First Floor
TAPE RECORDER
CENTRE

LARGEST RANGE
OF RECORDERS
& ACCESSORIES
IN THE NORTH

KING'S SQ.
YORK



SUBSCRIBE TO TRM

and receive your monthly
copy by post for 1 whole
year (12 issues). Send 25s.
(U.S.A. \$3.75) by postal order
or cheque today.

25/-
U.S.A.
\$3.75

To: TAPE RECORDING MAGAZINE,
Prestige House, 14-18 Holborn, London, E.C.1

Name.....
Address.....
.....
.....

NEW PRODUCTS

SWITCHED LMC MIKES

THE popular London Microphone Company's dynamic cardioid microphone LM 200 is now available in a switched version. Performance data is identical to that of the ordinary LM 200 and the cost will be 20s. higher than that of the equivalent unswitched models.

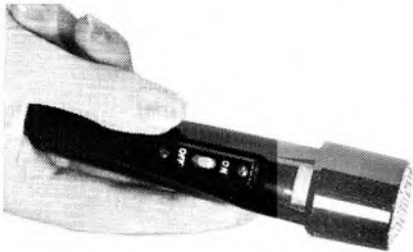

These latter are LM200/50 at 200 or 500 ohms impedance price £4 19s. 6d. and LM 200/dual impedance 50,000 and 200 ohms £5 15s. All prices include table wire stand and a full range of accessories is available.

London Microphone Co. Ltd., Eardley House, 182/4, Campden Hill Road, Kensington, London, W.8.

CEILINGS FOR THE STUDIO

READERS who have been following John Borwick's advice on the requirements of a home recording studio will be interested in the details of what is claimed to be the first sound absorbent acoustic ceiling to be specially designed for the home and which can be easily fitted by do-it-yourself methods over a single week-end.

This product has been introduced by Illuminated Ceilings Limited and the all-in cost is only 6s. per square foot complete delivered by passenger train. It is claimed that practical tests have proved that the panels will effectively absorb between 60 and 80 per cent of room noise and will also considerably muffle sounds originating from outside. The ceiling also acts as an effective thermal insulator thus reducing the cost of room heating.

In addition to the primary function of sound absorption and insulation the ICL acoustic ceiling will conceal light fittings, ugly blemishes, damaged plaster, unsightly wiring or plumbing, damp stains and mould, and the panels are guaranteed not to warp, buckle or sag, are vinyl covered and can be removed quickly and simply for washing with warm water and detergent.

The acoustic ceiling kit comprises extruded aluminium framing finished in a range of four shades—standard silver anodised, gold, light blue and black, plus two feet square in-fill panels. Fitting is claimed to be exceptionally easy, even simpler than



laying do-it-yourself floor tiles. Full details can be obtained from:

Illuminated Ceilings Limited, Station Works, Datchet, Buckinghamshire.

SPECIALISED GROUP MIKE

SENNHEISER Electronic have developed a new medium priced, anti feed-back microphone specially for the popular music industry. The MD 409 has been designed with very steep attenuation at its sides as well as at its back. The object is to allow the user to place the microphone in close proximity to a loudspeaker (such as is commonly used in beat groups' amplifiers connected to electric instruments) without having any problems of feed-back.

The bass response of the MD 409 has been modified to allow a vocalist to perform within a few inches of the microphone without producing over-emphasis in the bass frequencies. With this application in mind the instrument has a built-in anti popping shield.



Output impedance is 200 ohms balanced and the microphone is fitted with a silent on/off switch. Finished in black and gold and supplied in a cushioned transit case complete with gilt Tuchel connector, the retail price is £29 17s.

Sole importers Audio Engineering Limited, 33 Endell Street, London, W.C.2; distributors to the trade Audio and Design (Sales) Limited, 40 Queen Street, Maidenhead, Berkshire.

ANOTHER B & O MODEL

AN already impressive range of audio equipment by Bang & Olufsen is now supplemented by yet another model, the Beomaster 1400.

This sophisticated and versatile table radio combines a five wave-band radio receiver with a stereo amplifier. The cabinet is of modern and functional design, typical of Danish styling, and is available in two versions: Model K incorporating a pressure chamber loudspeaker at either end, and Model M which is technically identical but omits the two built-in loudspeakers.

A clearly marked and illuminated tuning scale on the front of the model displays the five wavebands, FM, Long, Medium, Shortwave (66-200 metres) and Shortwave (16-49 metres) with band spread. Four FM presets are provided for instantaneous push-button selection together with a stereo decoder which is claimed to be capable of receiving

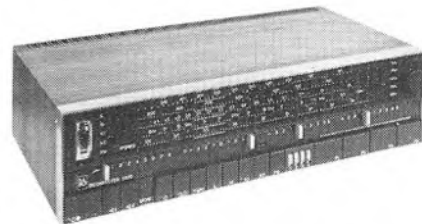

all stereo transmissions now and in the future.

Cabinets may be in teak or rosewood and the prices are: Beomaster 1400K 103 guineas, Beomaster 1400M 95 guineas.

Bang & Olufsen U.K. Division, Eastbrook Road, Gloucester.

THEFT OF AUDIO EQUIPMENT

A QUANTITY of Bang & Olufsen and Sony equipment was stolen from a delivery van in Chiswick, London, on 11th January. The equipment was part of a consignment for the London area and comprised portable and table radios, tape recorders, gram decks, amplifiers and loudspeakers. It is probable that these goods will be offered privately to the trade or to private individuals.

As all B & O and Sony equipment is distributed by Debenhams Electrical and Radio Distribution Co. Ltd. or their accredited dealers anyone who is offered such equipment is asked to co-operate by contacting them at Eastbrook Road, Gloucester, telephone number Gloucester 21591 quoting serial numbers if possible. Alternatively, if offered audio equipment of either of these makes in suspicious circumstances please contact your local police station at once.

CONSTRUCTORS' RECORDER KIT

DO-IT-YOURSELF enthusiasts will be pleased to note a new addition to the Heathkit catalogue—a transistorised portable stereo tape recorder Model STR1.

The equipment offers complete recording and playback facilities in one compact cabinet that is easy to carry from room to room or house to house. The BSR TD10 tape deck offers three speeds, $7\frac{1}{2}$, $3\frac{3}{4}$ and $1\frac{7}{8}$ ips. Facilities include sound on sound and sound with sound. Frequency response is claimed to be 40-18,000 Hertz at $7\frac{1}{2}$ ips and at the same speed wow and flutter is quoted as 0.15 per cent RMS. Unweighted signal-to-noise ratio is quoted as better than 40 dB and output as 4 watts RMS into 15 ohms per channel. Two 8" x 5" 15 ohm speakers are built-in and the equipment is supplied complete with moving coil microphone (mono).



As is usual with Heathkit models, the STR1 may be purchased either as a kit for home building at £45 18s. or as a factory built appliance at £59 15s. Full details are available from:

Daystrom Limited, Gloucester.

CASSETTES GO PRO

MORE and more interest is being aroused by the apparently infinite applications of the cassette principle. Latest in the market is the Rola Division of Plessey Components (Australia) Limited.

The new product is being marketed as the CT80 unit and is supplied in rack mounted, desktop mounted and recessed, flush-mounted versions. Each version operates with either three, five or seven inch cartridge containers and all are available as either record-and-play or playback-only models. An interesting feature is an optional



"trip cue" attachment which is available with all models. This enables cuetones of different frequencies to be recorded at various intervals along the tape, either whilst making the recording or at a later date. On subsequent replay these signals are used to operate associated relays performing such functions as operating a slide projector, starting a film projector or separate tape unit or activating warning lights.

The desktop and recessed versions are intended primarily for radio stations and dimensions of a desktop model are $7\frac{1}{2}$ inches high, $12\frac{1}{2}$ inches wide and $11\frac{1}{2}$ inches deep. The rack mounted CT80 is designed to fit into a standard 19 inch equipment rack and occupies $8\frac{3}{4}$ inches of vertical space. Potential uses are for background music studios and recorded information centres such as at airports and railway stations and also of course for TV and radio stations for remote control applications. All inquiries should be directed to:

The Liaison Office, Plessey Australia, The Plessey Company Limited, Ilford, Essex.

CANS FOR QUALITY

PRIVATE listening by means of headphones is becoming ever more popular. A good headset will give better reproduction than an indifferent loudspeaker.



The Telex Adjustatone headphone now available from Transatlantic Music Tapes (Distributors) Limited claims to reproduce full bass sound to surpass any other headphone made. In addition it has the special adjustatone feature which allows wide frequency response but provides for scratch and hiss elimination.

Frequency response is claimed as from 10-15,000 Hertz, weight is 12 ounces and operating impedances are from 3-16 ohms. Distortion is claimed as less than 1 per cent at levels below the threshold of pain. Retail price 9½ guineas.

Similar distortion levels and frequency response is claimed for the Telex Combo stereophonic headphone. Also operating on impedances from 3-16 ohms these phones require less than 1/15th of a watt driving power. Earcups are injection moulded of rugged high impact plastic and the foam-filled vinyl ear cushions provide a near perfect acoustic seal and are removable to allow for cleaning. Price of the Telex Combo stereophonic headphones is 11 guineas. Illustrated top right.

Transatlantic Music Tapes (Distributors) Limited, Bristol and Westhouse, High Street, Salisbury, Wilts.



LARGE-SIZE HUBS

ONE of the simplest ways to improve short-term speed stability is to use a take-up spool fitted with a larger than normal diameter hub. In the early days of magnetic recording spools had very small diameter hubs indeed; hub diameters were standardised later at the present familiar size.

A new type of empty spool is now being made available through the retail trade for the first time at 6s. 6d. for a seven-inch spool with four-inch hub at 4s. 6d. for a five-inch spool with three-inch hub. Both sizes are boxed and prices include postage and packing.

Transatlantic Music Tapes Limited, Bristol and Westhouse, 36, High Street, Salisbury, Wiltshire

SINGLE PLAYER BY GARRARD

ALTHOUGH not described as a "transcription unit," Garrard Engineering Limited refer to their new Model AP 75 as a high quality, single record player incorporating advanced features at a moderate price. Equipped with a four pole induction motor, Model AP75 incorporates many proven Garrard features. These include cue and pause facilities, calibrated pick-up stylus adjustment and pick-up arm bias compensation. An important new feature is a slide-in cartridge carrier permitting rigid construction of the pick-up arm and head which is claimed to reduce resonance. As well as manual control this unit offers the additional facility of automatic play of single records.



Model AP 75 is fitted with a non-magnetic turntable recessed into the unit plate which together with the slim depth measurement of the specially designed diecast aluminium pick-up arm gives an attractive "lowline" look. The recommended retail price inclusive of purchase tax is 21½ guineas.

Garrard Engineering Limited, Newcastle Street, Swindon.

CLASSIFIED ADVERTISEMENTS

Rate.—One shilling per word: box numbers, 2s. 6d. extra. Payment with copy, which should be sent to Advertising Department, "Tape Recording Magazine," Prestige House, 14-18, Holborn, London, E.C.1.

NEW EQUIPMENT

TAPE RECORDERS SAVE FROM 30 per cent to 60 per cent on the original price. Large stocks of second-hand, new, shop-soiled machines. All guaranteed. Obtainable on our **NO INTEREST TERMS**. Best part exchange allowances on your existing equipment. CALL, WRITE, PHONE today for free list. Quotation and details. Our Mail Order covers the whole country.—R. E. W. Earlsfield Ltd., 266, Upper Tooting Road, London, S.W.17. BALham 9174-5.

FOR SALE

BLACKBURN has Lancashire's leading Hi-Fidelity/Tape Recorder stockists and Electronic Engineers at HOLDINGS AUDIO CENTRE, MINCING LANE/DARWIN STREET, BLACKBURN (Tel. 59595).

STEREO TAPE RECORDERS for sale (Private). Revox 736 tape recorder, Akai X355D tape unit and Brenell STB1 tape unit. Phone 01-262 9627, evenings only. (Near Marble Arch.)

AKAI M.7. Complete with MICROPHONE and S.100 SPEAKERS. Mint condition. £75 o.n.o. Tel.: Day 01-267 0565; Eve. 01-340 4673.

MINIFLUX 4-Track stereophonic/monophonic record / playback heads. List Price 6 gns.—Special Offer 55/- each. **MINIFLUX** 4-Track stereophonic/monophonic Ferrite Erase Heads. List Price £3 10s.—Special Offer 32/6 each, or supplied together (one of each) at £3 17s. 6d. **SKN4** 1-Track stereophonic record/play heads for Transistor Circuits 55/- each. Also 1-track and full-track monophonic Ferrite Erase Heads complete with technical specifications. S.A.E. for details. **LEE ELECTRONICS**, 400 Edgware Rd., Paddington 5521.

30 per cent OFF BASF TAPE. LP 7-inch reel 1,800 ft. 33s. 3d.; DP 7-inch reel 2,400 ft. 52s. 6d. P. & P. 5s. per order. W.S.L., 104, Norwood High Street, S.E.27.

GEE'S RECORDING TAPE and AUDIO ACCESSORIES cost LESS! Send 1s. for illustrated catalogue, Gee Bros. Radio, 15, Little Newport Street, London, W.C.2. Gerrard 6794.

20% CASH DISCOUNT on Hi-Fi equipment, Radiograms, Radios, Tape Recorders, Cameras, Type-writers, etc. Join England's largest Mail Order Club now and enjoy the advantages of bulk buying, send 5s. for membership card, catalogues, price lists or s.a.e. for free quotation and leaflets. C.B.A. (Dept. A5), 370, St. Albans Road, Watford, Herts.

REPAIRS

OUR MODERN SERVICE DEPARTMENT equipped with the latest test equipment including a wow and flutter meter and multiplex Stereo Signal Generator is able to repair Hi Fi and Tape Recording Equipment to manufacturer's standard. **TELESONIC LTD.**, 92, Tottenham Court Road, London, W.1. 01-636 8177.

TAPE DUBBING

E.R.S. RECORDS: TAPE/DISC Vari-groove High Level Recordings with WIDE FREQUENCY RANGE. Top quality pressings. 162, SHIRLAND ROAD, LONDON, W.9.

WIMBLEDON'S TAPE RECORDER CENTRE

SKILLED TAPE RECORDER REPAIRS carried out by expert personnel of many years' experience backed by extensive test equipment—Wow & Flutter Meter, Audio Valve Voltmeter, Audio Generator, Oscilloscope, etc. with final test performance figures quoted if required. Ferroglyph specialists.

Tape Recorder Centre **TEL-LEE-RADIO 220 The Broadway, Wimbledon, S.W.19. 01-542 4946**

ROBINS FERRODYNAMIC TAPE

AMERICAN MANUFACTURE—SUPPLIED IN SEALED BOXES AND FULLY GUARANTEED:—

7" 2400 ft. Polyester 28/6	5 3/4" 1800 ft. Polyester 24/-
7" 1200 ft. Acetate 15/-	5 3/4" 1200 ft. Polyester 19/6
7" 1800 ft. Polyester 24/-	5" 600 ft. Acetate 9/9
7" 1800 ft. Acetate 18/6	5" 1200 ft. Polyester 16/6
5 3/4" 1200 ft. Acetate 15/-	3" 300 ft. Polyester 7/6

FOR FULL CATALOGUE OF TAPES, ACCESSORIES, COMPONENTS AND AUDIO EQUIPMENT, SEND S.A.E. TO:—
"MAILWAY", No. 1, Icknield Street, Dunstable, Beds.

ENGINEERS - OPPORTUNITIES IN TAPE-RECORDING

The Tape Manufacturing Company, a subsidiary of the E.M.I. Group, is expanding its activities and has immediate vacancies for:-

APPLICATIONS ENGINEER

To investigate and evaluate the performance of magnetic tape on new types of professional and domestic recorders. Applicants should have a sound knowledge of recording techniques, and hold a minimum qualification of O.N.C.

Commencing salaries and staff benefits are good, and grants towards re-location expenses may be made in suitable cases.



Applications, giving concise details of qualifications and experience to:-
P. JONES · GROUP PERSONNEL DEPT · E.M.I. LIMITED · BLYTH ROAD · HAYES · MIDDLESEX

AUDIO MAINTENANCE ENGINEER

To maintain and modify test equipment and tape recording equipment used in the evaluation of magnetic tape.

Applicants should be aged 20-40, and have some experience in the recording field.

DEVELOPMENT ENGINEER

To design transistor and logic circuits, and be able to advise on the maintenance and repair of a wide range of test equipment including tape machines.

Applicants should hold an H.N.C. qualification, and have some experience of this type of work. A knowledge of tape-recording and audio and video equipment would be a definite advantage.

TAPE DUBBING (cont'd)

TAPE TO DISC service. Specialists in Location recordings, Demos, Weddings, Sound Equipment, etc. Any distance. S.A.E. for leaflet. TRUSOUND Recording Services, 4, Hitchin Road, Shefford, Beds. Telephone: Shefford 355.

J. & B. RECORDINGS. Tape/disc. Mobile unit. Quality recording. 14, Willows Avenue, Morden, Surrey. Mitcham 9952.

JOHN HASSELL RECORDINGS. Tape-to-Disc Service using latest high level disc-cutting system. Quality pressings made. Studio with Bechstein Grand Mobile unit. 21, Nassau Road, London, S.W.13. RIVerside 7150.

YOUR TAPES to DISC, 7 in. 45—18s., 10 in. LP—48s., 12 in. LP—55s. 4-day postal service. Top professional quality. S.a.e. photo leaflet: DERBY STUDIOS, High Bank, Hawk St., Carnforth, Lancs.

TAPE EXCHANGES

FRIENDLY FOLK ASSOCIATION, Torquay (Est. 1943). Social Introductions, Pen-friends, Book-lovers, Stamps, Photography. Tapesponding. Members 100 countries.

MAKE INTERESTING NEW FRIENDS. Trial introductions free. VCC. 34, Honeywell, London, S.W.11.

THE LONDON TAPE RECORDING CLUB had its tenth birthday last year. Our meetings, held monthly in the Charing Cross area, are lively, creative occasions, and prospective new members will be welcome. Please write for details to: The Secretary, Mr. C. Clements, 36 Hubert Road, London, E.6.

Join TAPEMATES INTERNATIONAL and exchange tapes with friends throughout the World. Club and recording booths 6 p.m.-10.30 p.m. Tuesdays, Thursdays and Saturdays. 6, Holland Park Avenue, London, W.11.

FAR AND WIDE RECORDING CLUB, Eccles, Maidstone. Details free.—SAE.

WORLDWIDE TAPETALK magazine now available to non-members. Find out why tapetalking is today's most rewarding hobby! Send 1s. (stamps): WWTT, 35 The Gardens, Harrow.

MISCELLANEOUS

ALWAYS BE CAREFUL (and money wise) before buying quality equipment. Send your requirement list to AUDIO SUPPLY ASSOCIATION for evaluation and quotation. See below

HIGHEST CASH PRICES offered for good quality Tape Recorders and Hi-fi. See our advert., page 100 this issue. R.E.W., 266-8, Upper Tooting Road, London, S.W.17.

IF QUALITY MATTERS consult first our 65-page, photographically illustrated catalogue (5s. 6d.) and equipment housing guide (1s. 6d.). Members enjoy unbiased advisory service, preferential terms (cash only, no H.P.). Membership 7s. 6d. Our Associates also manufacture records from your own tapes, or record the Master at our studios (Steinway Grand). Bulk terms for choirs, fund-raising. Please specify requirements. AUDIO SUPPLY ASSOCIATION, 18, Blenheim Road, London, W.4. 995 1661.

TAPE RECORDS

ABSOLUTELY EVERY AMERICAN 4 TRACK STEREO TAPE released in America can be obtained through our special postal service. For complete and up-to-date catalogue of all releases send only 3s. to: MUSIC U.S.A., 146 Lower Baggot Street, Dublin 2, Ireland.

Every pre-recorded tape available in Britain is listed in the complete TELETAPE catalogue at 1s. 6d. post free.

Vast selection of Mono and Stereo tapes. Send now for your copy by return to: Mail Order Dept., TELETAPE Ltd., 11, Redvers Road, London, N.22, or call at our Marble Arch or Shaftesbury Avenue Showrooms.

Four-track Stereo Tapes are expensive! Join the W.S.L. Stereo Tape Library and enjoy every tape for only a few pence per day. Worldwide Service. Send 9d. postage for full details to: 104, Norwood High Street, London, S.E.27.

PUBLICATIONS

NOW IN ITS SECOND REPRINT, Alan Beeby's informative handbook SOUND EFFECTS ON TAPE. Invaluable to all dramatists and recording enthusiasts. Tells in practical terms not only what to do but also how and why. 3s. 6d. post free. Remittance with order to Print & Press Services, Prestige House, 14-18, Holborn, London, E.C.1.

EDUCATIONAL

LEARN WHILE YOU SLEEP: GCE and Professional subjects. Languages, etc. Free booklet from THE SLEEP LEARNING ASSOCIATION, 14 Belsize Crescent, London, N.W.3. Tel.: SWI 6160.

VACANCIES

TAPE RECORDER SERVICING ENGINEER required for central service department (East London) of Britain's largest tape recorder specialists. Telephone: Mr. Willis, GRAngewood 2110.

We still require Camera/Projector Repair Mechanics for Zeiss Ikon-Voigtlander, Eumig, Rollei and Braun. Semi-skilled men could be trained. Rebuilt fully equipped workshop. Good basic rate and generous bonus scheme. 5-day week (40 hrs.). Pension Scheme. Top Tray canteen service. Apply: Mr. J. Allard, Johnsons of Hendon Ltd., 970 North Circular Road, N.W.2. 01-452 6544.

ADVERTISMENT INQUIRIES SERVICE

I should like further information about Messrs 's advertisement on page..... of TAPE Recording Magazine about..... (product) NAME..... ADDRESS

March 1968

This is a special service for readers of "TAPE Recording Magazine." It enables you without cost to get fuller information about those products in which you are particularly interested. Fill in one coupon below for each inquiry, with your name and address in block capitals in each case. Then cut out the whole of this section, following the dotted line, fold as indicated overleaf and post to us.

I should like further information about Messrs 's advertisement on page..... of TAPE Recording Magazine about..... (product) NAME..... ADDRESS

March 1968

I should like further information about Messrs 's advertisement on page..... of TAPE Recording Magazine about..... (product) NAME..... ADDRESS

March 1968

I should like further information about Messrs 's advertisement on page..... of TAPE Recording Magazine about..... (product) NAME..... ADDRESS

March 1968

I should like further information about Messrs 's advertisement on page..... of TAPE Recording Magazine about..... (product) NAME..... ADDRESS

March 1968

ONLY ENGLISH ANNUAL TO DEAL EXCLUSIVELY WITH TAPE RECORDING SEND NOW FOR LATEST EDITION

Fill-in & Post this Coupon with Remittance Today! 

To: TAPE Recording Magazine, PRESTIGE HOUSE, 14-18 HOLBORN, LONDON, E.C.1
Please send me.....copy(ies) of TAPE Recording YEAR BOOK 1966, at 7s. 6d.
(U.S.A. \$1.25) per copy POST FREE. I enclose remittance.

NAME

ADDRESS.....



TAPE YEAR BOOK the Recordist's Reference

PRICE
7/6

- ★ The only available up-to-date comprehensive catalogue of TAPE RECORDERS on the market with full specifications, price, etc., plus photographs.
- ★ Review of tape developments during the past year.
- ★ Manufacturers, dealers and Club Secretaries' addresses.
- ★ GLOSSARY of technical terms, "at-a-glance" tabulated catalogues of microphones, tuners, mixers, and associated accessories; Magnetic Tape Charts, etc.

On sale at bookstalls or direct from publishers using coupon above

CUT ALONG DOTTED LINE

POSTAGE
WILL BE
PAID BY
PRINT AND
PRESS
SERVICES
LIMITED

TAPE RECORDING MAGAZINE,
PRESTIGE HOUSE,
14-18 HOLBORN,
LONDON, E.C.1

BUSINESS REPLY FOLDER
Licence No. ND 922

THIRD FOLD HERE

SECOND FOLD HERE

FLAP A

FLAP B

NO POSTAGE
STAMP
NECESSARY
IF POSTED
IN GREAT
BRITAIN OR
NORTHERN
IRELAND

FIRST FOLD ALONG THIS LINE

Fold along lines as indicated and then tuck Flap A into Flap B



To ALL OWNERS of
Tape Recorders!
SPECIAL OFFER



NEW

High-grade Magnetic Recording Tape. Polyester and PVC. Specially coated. Sensitive. Clear and durable. Appreciated by discerning people. Musicians. Publishers. Pedagogues. Amateurs. Experts, Professionals.

Dear Sir,
Thank you for your service to us members of the Tape World.

S.T., Beds.

New	3"	5"	5 1/2"	7"
Std. Play each	150'	600'	850'	1200'
3 for	2/- 5/9	5/6 16/-	7/- 20/-	8/6 25/-
Long Play each	240'	900'	1200'	1800'
3 for	3/- 8/6	7/6 22/-	9/6 27/9	12/6 36/9
Dble. Play each	300'	1200'	1800'	2400'
3 for	4/3 12/3	11/- 32/3	15/- 44/-	19/9 58/3

Also full Range of Triple: List Free

Postage 1/6 per order.
Posted the same day.
Money-back gtd.

Mora Trading Co. (T2)
Mora Works, Mora Road, N.W.2

A MAJOR BREAKTHROUGH IN TAPE-LEARNING ECONOMICS

At last we are able to offer a recorder which is not only ideal for Tape-Learning and Therapy and gives excellent results on music but is at the same time at a sensationally low price—only 25 gns.

Send now for our latest free catalogue of Complete Tape-Learning Kits and accessories including our special Induction Tapes, Pillow Speakers, Time Switches, etc., etc., together with latest Press Reports on this Vital New Subject.

THE INSTITUTE OF TAPE-LEARNING

Dept. TRM, 153, FELLOWS ROAD, SWISS COTTAGE, LONDON, N.W.3.
01-722 3314

The Berean
Forward Movement

(NON DENOMINATIONAL)

Loan of over 1,000 reliable expositions of the Bible available on tape (3 1/2 ips) for cost of postage only. For Bible Study groups or private meditation. Supporting literature also available. Details from: Miss R. Hammond (TRM), Burwood, Blofield, NORWICH, Norfolk. NOR 84Z.

add
rhythm

to your
own
melody

volume 2
latin american



ADD DRUMS AND PERCUSSION RHYTHM BACKING TO YOUR OWN MELODY. PLAY WITH ANY TUNE IN ANY KEY

- Vol. 1 Quickstep, Foxtrot, Waltz, Cha-Cha.
- Vol. 2 Bossa Nova, Samba, Rhumba, Tango.
- Vol. 3 Twist, Slow Ballads, Rock-a-Latin, Two Beat.

13/- each by post from
AD-RHYTHM PRODUCTIONS LTD.
Broadwalk, Pinner Road, North Harrow, Middx. 01-862 1841.

RAPID RECORDING SERVICE

L.P.s. from your own tapes. (48-hour service)
Master Discs and pressings.
Recording Studio. Mobile Recordings.
Associated Company—

EDUCATIONAL RECORDINGS LTD.

Is your mind managing you??
Do you often find it difficult to make decisions?
Do you brood over your troubles?
Send now for Psycho-tape No. S.T./1 "Mind Management."
Twenty other tapes on self-improvement.
Publications:—
"Sleep-learning, Its Theory, Application and Technique."
"Mental Power Through Sleep-suggestion."
"How to Get What You Want" by Sidney N. Bremer.

Brochures from
RAPID RECORDING SERVICE (Dept. TRM)
21 Bishops Close, London, E.17

**TAPE
RECORDER
CENTRE**

**KENT
AND S.E. LONDON**

**Tandberg
SPECIALISTS**

COMPLETE RANGE IN STOCK

Akai, Ampex, B & O, Brenell, E.M.I., Elizabethan, Ferguson, Ferrograph, Grundig, Loewe-Opta, National, Philips, Reps, Revox, Sanyo, Sharp, Sony, Telefunken, Truvox, Uher, Van Der Molen, Vortexion, Wyndson, etc., together with a wonderful range of Hi-Fi equipment

WHEREVER YOU LIVE IN KENT OR S.E. LONDON
THE NUSOUND TAPE RECORDER CENTRE IS YOUR
BEST CHOICE FOR

- PERSONAL AND EXPERT ADVICE
- EASY HIRE PURCHASE TERMS
- GENEROUS PART EXCHANGES
- FREE AFTER SALES SERVICING

**36, LEWISHAM HIGH STREET,
LONDON, SE.13**

Telephone: LEE GREEN 2399

(Situated only one minute from Lewisham Station)



MUSICCASSETTES

**THE ONLY CASSETTE SYSTEM
FEATURING CLASSICAL HIGHLIGHTS**



GRIEG: Piano Concerto, (Claudio Arrau) Peer Gynt Suites 1 and 2 (Annette de la Bije) Concertgebouw Orchestra, Amsterdam Conductors: Christoph von Dohnanyi Jean Fournet **CPC0014**



VIVALDI: Concerti for Various Solo-Instruments Moscow Chamber Orchestra conducted by Rudolf Barschai **CPC0023**



SCHUBERT: Incidental Music to "Rosamunde" Aafje Heynis, contralto Concertgebouw Orchestra, Amsterdam Netherlands Radio Chorus Conductor: Bernard Haitink **CPC0015**



TCHAIKOVSKY The Swan Lake London Symphony Orchestra conducted by Pierre Monteux **CPC0003**



LISZT: Piano Concertos Nos. 1 and 2 Sviatoslav Richter London Symphony Orchestra conducted by Cyril Kondrashin **CPC0008**



BERLIOZ Symphonie Fantastique London Symphony Orchestra conducted by Colin Davis **CPC0004**



JOHANN STRAUSS Favourite Waltzes Vienna Concert Orchestra conducted by Kurt Richter **CPC0001**



BRAMHS Violin Concerto in D major **BEETHOVEN** Violin Romance No. 1 Concertgebouw Orchestra, Amsterdam Arthur Grumiaux Conductors: Bernard Haitink Eduard Van Beinum **CPC0013**



For full details of other Musicassette releases, please write to Musicassettes Department, Philips Records Limited, Stanhope House, Stanhope Place, London, W.2